

BT CHU CNC DRILL CHUCK

BT 直結式鑽夾頭

BT Shank JIS B 6339 (MAS 403 BT)

APPLICATION:

- The product can be adapted for the general lathe or the drilling processing whose machines center can supply with BT spindle.
- 適用於傳統銑床或其他提供BT主軸介面之工作母機作鑽孔加工。

FEATURES:

- 3 times better clamping capacity, comparing to keyed drill chucks.
- The drill bit won't be loosen or falling off.
- Twice precision than the keyed drill chucks.
- The drill chuck is interchangeable.
- 比普通夾頭多3倍的夾持力
- 鑽頭不會鬆脫或掉落
- 比普通夾頭多出2倍精準
- 可替換式的夾頭

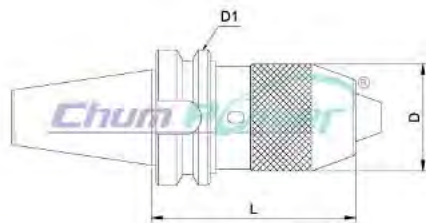

Code NO. 型號	TYPE 規格	L	D	D1	Spanner No. 扳手編號
BT01505	BT30xCHU8- 75	75	37	46	12802
BT01510	BT30xCHU13- 90	90	50		12806
BT01515	BT40xCHU8- 85	85	37	63	12802
BT01525	BT40xCHU13-95	95	50		12806
BT01545	BT40xCHU16-120	120	57		12808
BT01550	BT50xCHU13- 110	110	50	100	12806
BT01564	BT50xCHU16-110	110	57		12808

*Custom-built products are available on request.

BT ER COLLET CHUCK

BT刀把 ER立銑式

BT Shank JIS B 6339 (MAS 403 BT) with Collet Chuck DIN 6499

APPLICATION:

- The product can be applied for end mills, drill bits, drill reamers, taps, and can clamp any straight cutters and tools.
- 本產品可應用於銑刀、鑽頭、銼刀、絲攻及可夾持任何直柄的刀具及工具

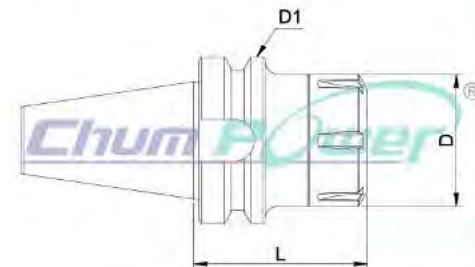

Code NO. 型號	TYPE 規格	L	D	D1	Spanner No. 扳手編號
BT02005	BT30xER11- 60	60	19	46	80072-01
BT02015	BT30xER16- 60	60	28		80072-02
BT02025	BT30xER16- 100	100			80072-03
BT02040	BT30xER20- 60	60	34		80072-04
BT02050	BT30xER20- 100	100	42		80072-05
BT02060	BT30xER25- 60	60	42	63	80072-04
BT02065	BT30xER25- 100	100			80072-05
BT02080	BT30xER32- 70	70	50	63	80072-06
BT02085	BT30xER32- 100	100			80072-07
BT02095	BT40xER11- 70	70	19	63	80072-01
BT02100	BT40xER11- 100	100	28		80072-02
BT02106	BT40xER16- 70	70			34
BT02110	BT40xER16- 100	100	100		80072-04
BT02131	BT40xER20- 70	70	42		80072-05
BT02140	BT40xER20- 100	100	50		80072-06
BT02155	BT40xER25- 70	70	70		80072-07
BT02165	BT40xER25- 100	100	63		80072-08
BT02185	BT40xER32- 70	70	78		80072-09
BT02190	BT40xER32- 100	100	90		80072-10
BT02200	BT40xER40- 70	70	78	63	80072-06
BT02205	BT40xER40- 100	100			80072-07
BT02220	BT40xER50- 90	90	78	63	80072-06
BT02225	BT40xER50- 100	100			80072-07

*Custom-built products are available on request.



BT ER COLLET CHUCKS

BT刀把 ER立銑式 BT Shank JIS B 6339(MAS 403 BT) with Collet Chunk DIN 6499

APPLICATION:

- The product can be applied for end mills, drill bits, drill reamers, taps, and can clamp any straight cutters and tools.
- 本產品可應用於銼刀、鑽頭、鉸刀、絲攻及可夾持任何直柄的刀具及工具

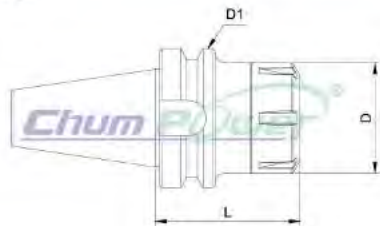

Code NO. 型號	TYPE 規格	L	D	D1	Spanner No. 扳手編號
BT02230	BT50xER16-70	70	28	100	80072-02
BT02240	BT50xER16-100	100			
BT02265	BT50xER20-70	70	34		80072-03
BT02280	BT50xER20-105	105			
BT02310	BT50xER25-70	70	42		80072-04
BT02320	BT50xER25-105	105			
BT02350	BT50xER32-80	80	50		80072-05
BT02355	BT50xER32-100	100			
BT02380	BT50xER40-80	80	63		80072-06
BT02410	BT50xER50-100	100			
BT02415	BT50xER50-120	120	78	80072-07	

*Custom-built products are available on request.



BT MILLING CHUCKS

BT 強力式立銑刀把 BT Shank JIS B 6339(MAS 403 BT)

FEATURES:

- It is designed with inner rolling needles inside. This design can reduce the friction resistance when tightening and the wear of parts.
- The design of dustproof can prevent iron scrap dropping and extend longevity of chuck.
- The high clamping force is available. The product can prevent the cutting tools from slipping when the users worked it and increase the longevity of cutting tools.
- High rigidity
- High precision

特性

- 內部滾針設計，可減少鎖緊時之摩擦阻力及零件磨耗。
- 防護設計減少鐵屑掉入以延長使用壽命。
- 高夾持力，防止刀具於加工時滑脫，增加刀具壽命。
- 高剛性
- 高精度

APPLICATION:

- The Milling chuck can be applied for heavy-duty & higher accuracy cutting.
- 此強力銑刀把適用重型及高精密切削

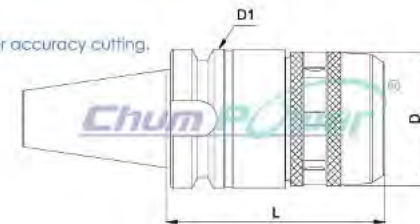

Code NO. 型號	TYPE 規格	L	D	D1	Spanner No. 扳手編號
BT03005	BT30xC20-80	80	52	46	80200-05
BT03015	BT30xC25-85	85	60		80200-10
BT03020	BT40xC20-85	85	52	63	80200-05
BT03025	BT40xC20-100	100			
BT03030	BT40xC20-135	135			
BT03035	BT40xC25-90	90	60		80200-10
BT03040	BT40xC25-135	135			
BT03055	BT40xC32-105	105	69		80200-15
BT03065	BT40xC32-135	135			
BT03070	BT50xC20-105	105	52	100	80200-05
BT03075	BT50xC20-150	150			
BT03080	BT50xC25-100	100	60		80200-10
BT03085	BT50xC25-150	150			
BT03095	BT50xC32-110	110	69		80200-15
BT03100	BT50xC32-135	135			
BT03125	BT50xC42-110	110	86		80200-20
BT03130	BT50xC42-135	135			

*Custom-built products are available on request.



BT SIDE LOCK END MILL HOLDER

BT 側固式立銑刀把

BT Shank JIS B 6339(MAS 403 BT) with Side Lock End Mill 1835B

APPLICATION:

- It can be applied for heavy cutting and milling process generally. □ 適用於重切削及一般銑削加工
- The cutting tools can be clamped precisely. Even if it's worked in heavy cutting, it will not result in slipping on cutting tools. □ 刀具夾持確實，即使重切削亦不致造成刀具滑動

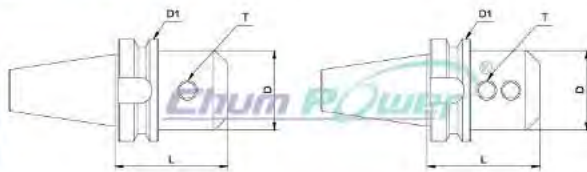

FIG.1

FIG.2

Code NO. 型號	TYPE 規格	L	D	D1	T	FIG. 圖
BT04005	BT30xSLN6- 60	60	25	46	M6	1
BT04010	BT30xSLN8- 60	60	28	46	M8	1
BT04015	BT30xSLN10- 60	60	35	46	M10	1
BT04020	BT30xSLN12- 60	60	42	46	M12	1
BT04025	BT30xSLN16- 75	75	48	46	M14	1
BT04030	BT30xSLN20- 75	75	52	46	M16	1
BT04040	BT30xSLN25- 90	90	65	46	M18	2
BT04050	BT40xSLN6- 75	75	25	63	M6	1
BT04070	BT40xSLN8- 75	75	28	63	M8	1
BT04085	BT40xSLN10- 63	63	35	63	M10	1
BT04105	BT40xSLN12- 63	63	42	63	M12	1
BT04125	BT40xSLN14- 75	75	44	63	M12	1
BT04135	BT40xSLN16- 63	63	48	63	M14	1
BT04155	BT40xSLN18- 63	63	50	63	M14	1
BT04190	BT40xSLN25- 90	90	65	63	M18	2
BT04200	BT40xSLN32- 100	100	72	63	M20	2
BT04205	BT40xSLN40- 105	105	79	63	M20	2
BT04210	BT40xSLN42- 105	105	79	63	M20	2

*Custom-built products are available on request.

BT SIDE LOCK END MILL HOLDER

BT 側固式立銑刀把

BT Shank JIS B 6339(MAS 403 BT) with Side Lock End Mill 1835B

APPLICATION:

- It can be applied for heavy cutting and milling process generally. □ 適用於重切削及一般銑削加工
- The cutting tools can be clamped precisely. Even if it's worked in heavy cutting, it will not result in slipping on cutting tools. □ 刀具夾持確實，即使重切削亦不致造成刀具滑動

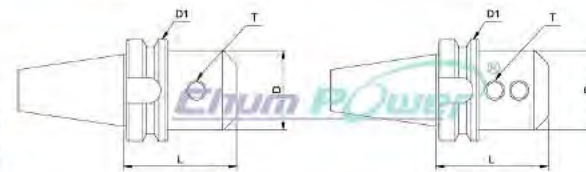

FIG.1

FIG.2

Code NO. 型號	TYPE 規格	L	D	D1	T	FIG. 圖
BT04215	BT50xSLN6- 63	63	25	100	M6	1
BT04225	BT50xSLN8- 63	63	28	100	M8	1
BT04235	BT50xSLN10- 65	65	35	100	M10	1
BT04245	BT50xSLN12- 80	80	42	100	M12	1
BT04255	BT50xSLN14- 105	105	44	100	M12	1
BT04260	BT50xSLN16- 80	80	48	100	M14	1
BT04270	BT50xSLN18- 105	105	50	100	M14	1
BT04275	BT50xSLN20- 80	80	52	100	M16	1
BT04295	BT50xSLN25- 100	100	65	100	M18	2
BT04320	BT50xSLN32- 105	105	72	100	M20	2
BT04340	BT50xSLN40- 105	105	80	100	M20	2
BT04350	BT50xSLN42- 105	105	80	100	M20	2
BT04375	BT50xSLN50- 120	120	98	100	M24	2
BT04380	BT50xSLN63- 135	135	125	100	M24	2
BT04385	BT50xSLN50.8- 105	105	100	100	M24	2

*Custom-built products are available on request.

BT FACE MILL HOLDER

BT 面銑式立銑刀把

BT Shank JIS B 6339(MAS 403 BT) with Face Mill DIN 6357

APPLICATION:

- The product can be applied for Face milling.
- 本產品適用於平面銑削加工

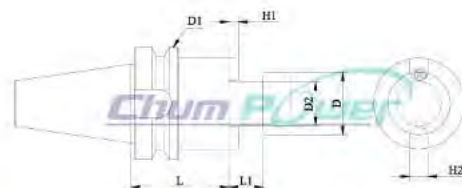

Code NO. 型號	TYPE 規格	L	L1	D	D1	D2	H1	H2
BT06010	BT30xFMA25.4-60	45	20	35	46	25.4	4.52	9.52
BT06015	BT30xFMA31.75- 45	45	22	41	46	31.75	6.7	12.7
BT06020	BT40xFMA25.4- 45	45	20	35	63	25.4	4.52	9.52
BT06040	BT40xFMA31.75- 45	45	22	41	63	31.75	6.7	12.7
BT06055	BT40xFMA38.10- 90	90	25	44.5	63	38.10	8.87	15.87
BT06065	BT50xFMA25.4- 45	45	20	35	100	25.4	4.52	9.52
BT06090	BT50xFMA31.75- 105	105	22	41	100	31.75	6.7	12.7
BT06095	BT50xFMA38.10- 45	45	25	44.5	100	38.10	8.87	15.87
BT06105	BT50xFMA50.80- 45	45	36	68	100	50.80	9.75	19.05
BT06115	BT50xFMA47.62- 75	75	32	-	100	47.62	12.5	25.4

*Custom-built products are available on request.

BT FACE MILL HOLDER

BT 面銑式立銑刀把

BT Shank JIS B 6339(MAS 403 BT) with Face Mill DIN 6357

APPLICATION:

- The product can be applied for Face milling.
- 本產品適用於平面銑削加工

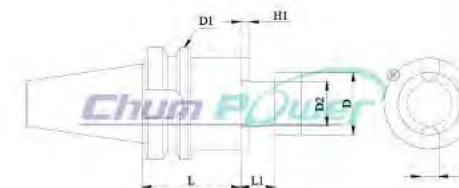

Code NO. 型號	TYPE 規格	L	L1	D	D1	D2	H1	H2
BT06120	BT30xFMB22- 45	45	18	26	46	22	4.8	10
BT06135	BT30xFMB27- 60	60	20	31.5	46	27	5.8	12
BT06142	BT30xFMB32- 60	60	22	41	46	32	6.8	14
BT06145	BT40xFMB22- 45	45	18	26	63	22	4.8	10
BT06160	BT40xFMB27- 45	45	20	31.5	63	27	5.8	12
BT06185	BT40xFMB32- 60	60	22	41	63	32	6.8	14
BT06190	BT40xFMB40- 60	60	25	48	63	40	8.3	16
BT06197	BT50xFMB22- 60	60	18	26	100	22	4.8	10
BT06220	BT50xFMB27- 60	60	20	31.5	100	27	5.8	12
BT06245	BT50xFMB32- 60	60	22	41	100	32	6.8	14
BT06255	BT50xFMB40- 60	60	25	48	100	40	8.3	16
BT06270	BT50xFS40F- 75	75	26	-	100	40	8.3	16
BT06275	BT50xFS60F- 75	75	25	-	100	60	12.5	25.4

*Custom-built products are available on request.



TOOLING SYSTEM

BT MORSE TAPER HOLDER

BT 莫式錐度刀把



BT-MTA

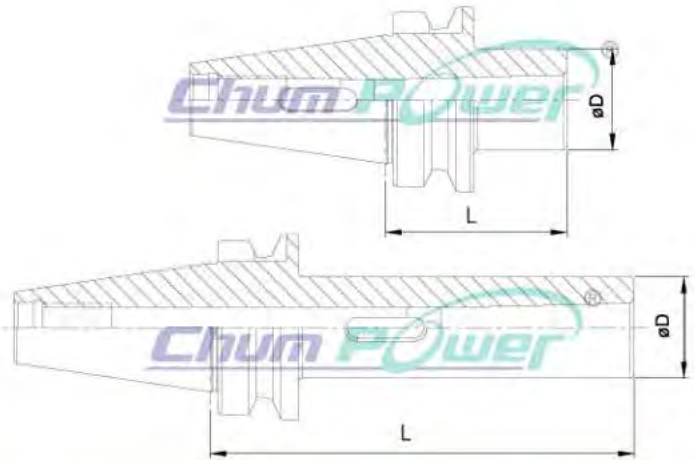

Code NO. 型號	TYPE 規格	L	ØD
BT10030	BT40-MTA1-45	45	25
BT10040	BT40-MTA2-50	50	32
BT10050	BT40-MTA3-70	70	40
BT10060	BT40-MTA4-95	95	50
BT10070	BT50-MTA1-45	45	25
BT10085	BT50-MTA2-60	60	32
BT10105	BT50-MTA3-65	65	40
BT10120	BT50-MTA4-95	95	50

BT MORSE TAPER HOLDER

BT 莫式錐度刀把



BT-MTB

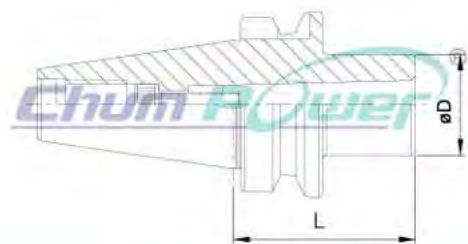

Code NO. 型號	TYPE 規格	L	ØD
BT10510	BT30-MTB1-45	45	25
BT10520	BT30-MTB2-60	60	32
BT10530	BT40-MTB1-45	45	25
BT10540	BT40-MTB2-45	45	32
BT10550	BT40-MTB3-70	70	40
BT10560	BT40-MTB4-90	90	48
BT10570	BT50-MTB1-45	45	25
BT10580	BT50-MTB2-45	45	32
BT10590	BT50-MTB3-60	60	40
BT10600	BT50-MTB4-75	75	50
BT10610	BT50-MTB5-120	120	70

TOOLING SYSTEM

BT CHUCK For High-Speed Machining

BT 高速刀桿 - 高速加工專用

APPLICATION:

- To prevent vibration and reduces noise by SK Nut (Notch-Free) □ 藉由SK螺母(無溝槽), 可避免加工時的晃動及降低噪音
- High Rigidity ■ High Accuracy ■ High Clamping Force □ 高剛性 □ 高精度 □ 高夾持力



※SK Collet is not included.
不含SK筒夾 (page E-45)

Code NO. 型號	TYPE 規格	ØD	L	ØC	L1		Collet
					Min	Max	
BT41005	BT30xSK6-60	0.7~6.0	60	19.5	21	35	SKC6
BT41015	BT30xSK10-60	1.75~10.0	60	30	30	50	SKC10
BT41025	BT30xSK16-60	2.75~16.0	60	40	40	60	SKC16
BT41035	BT30xSK20-60	4.0~20.0	60	48.5	50	70	SKC20
BT41040	BT30xSK25-90	16.0~25.4	90	55	55	75	SKC25
BT41045	BT40xSK6-60	0.7~6.0	60	19.5	21	35	SKC6
BT41060	BT40xSK10-60	1.75~10.0	60	30	30	50	SKC10
BT41080	BT40xSK16-60	2.75~16.0	60	40	50	65	SKC16
BT41100	BT40xSK20-60	4.0~20.0	60	48.5	47	60	SKC20
BT41120	BT40xSK25-90	16.0~25.4	90	55	55	75	SKC25
BT41130	BT50xSK6-100	0.7~6.0	100	19.5	21	35	SKC6
BT41140	BT50xSK10-100	1.75~10.0	100	30	30	50	SKC10
BT41150	BT50xSK16-100	2.75~16.0	100	40	40	70	SKC16
BT41165	BT50xSK20-100	4.0~20.0	100	48.5	47	80	SKC20
BT41180	BT50xSK25-100	16.0~25.4	100	55	50	85	SKC25

*Custom-built products are available on request. (BT, HSK, SK, NT, CAT Type) *特製品可依客戶需求訂製

CAT CHU CNC DRILL CHUCK

CAT 直結式鑽夾頭

CAT Shank ANSI B5.50

FEATURES:

- 3 times better clamping capacity, comparing to keyed drill chucks.
- The drill bit won't be loosen or falling off.
- Twice precision than the keyed drill chucks.
- The drill chuck is interchangeable.

- 比普通夾頭多3倍的夾持力
- 鑽頭不會鬆脫或掉落
- 比普通夾頭多出2倍精準
- 可替換式的夾頭

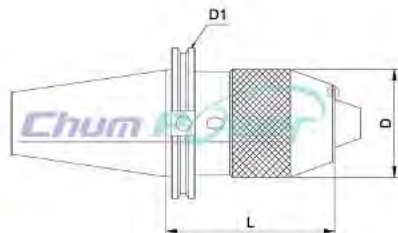

Code NO. 型號	TYPE 規格	L	D	D1	Spanner No. 扳手編號
CT01510	CAT30xCHU 8-3.347	3.347	1.456	1.812	12802
CT01520	CAT40xCHU 8-3.228	3.228	1.456	2.5	12802
CT01532	CAT40xCHU 13-4.527	4.527	1.968	2.5	12806
CT01540	CAT40xCHU 16-4.724	4.724	2.244	2.5	12808
CT01550	CAT50xCHU 13-3.54	3.54	1.968	3.875	12806
CT01560	CAT50xCHU 16-3.7	3.7	2.244	3.875	12808

*Custom-built products are available on request.

CAT ER COLLET CHUCK

CAT刀把 ER立銑式

CAT Shank ANSI B5.50 with Collet Chuck DIN 6499

APPLICATION:

- The product can be applied for end mills, drill bits reamers, taps, and can clamp any straight cutters and tools.
- 本產品可應用於銼刀, 鑽頭, 銼刀, 絲攻及可夾持任何直柄的刀具及工具

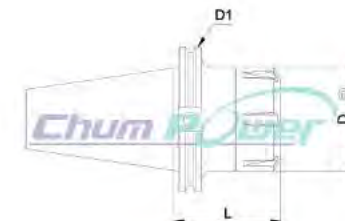

Code NO. 型號	TYPE 規格	L	D	D1	INCH SIZE 英制 Spanner No. 扳手編號
CT02005	CAT40xER16- 2.76	2.76	1.102	2.5	80072-02
CT02025	CAT40xER20- 2.76	2.76	1.339	2.5	80072-03
CT02040	CAT40xER25- 2.76	2.76	1.645	2.5	80072-04
CT02060	CAT40xER32- 2.76	2.76	1.969	2.5	80072-05
CT02080	CAT40xER40- 3.15	3.15	2.48	2.5	80072-06
CT02095	CAT40xER50- 4	4	3.07	2.5	80072-07

CT02100	CAT50xER16- 4	4	1.102	3.875	80072-02
CT02125	CAT50xER20- 4	4	1.339	3.875	80072-03
CT02140	CAT50xER25- 4	4	1.645	3.875	80072-04
CT02155	CAT50xER32- 4	4	1.969	3.875	80072-05
CT02170	CAT50xER40- 4	4	2.48	3.875	80072-06
CT02185	CAT50xER50- 4	4	3.07	3.875	80072-07

*Custom-built products are available on request.



CAT MILLING CHUCK

CAT 強力式立銑刀把

CAT Shank ANSI B5.50

FEATURES:

- It is designed with inner rolling needles inside. This design can reduce the friction resistance when lightening and the wear of parts.
- The design of dustproof can prevent iron scrap dropping and extend longevity of chuck.
- The high clamping force is available. The product can prevent the cutting tools from slipping when the users worked it and increase the longevity of cutting tools.
- High rigidity
- High precision

特性

- 內部滾針設計，可減少鎖緊時之摩擦阻力及零件磨耗。
- 防塵設計減少鐵屑掉入以延長使用壽命。
- 高夾持力，防止刀具於加工時滑脫，增加刀具壽命。
- 高剛性
- 高精度

APPLICATION:

- The Milling chuck can be applied for heavy-duty & higher accuracy cutting.
- 此強力銑刀把適用重型及高精度切削。

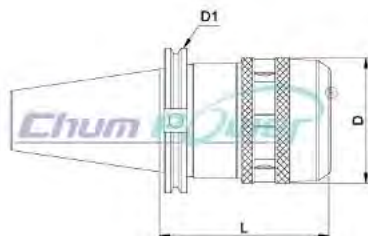

INCH SIZE 英制

Code NO. 型號	TYPE 規格	L	D	D1	Spanner No. 扳手編號
CT03010	CAT40xC3/4- 3.385	3.385	2.047	2.5	80200-05
CT03020	CAT40xC1-1/4- 4.53	4.53	2.716	2.5	80200-15
CT03025	CAT50xC3/4- 4.13	4.13	2.047	3.875	80200-05
CT03030	CAT50xC1-1/4- 4.13	4.13	2.716	3.875	80200-15

*Custom-built products are available on request.



CAT SIDE LOCK END MILL HOLDER

CAT 側固式立銑刀把

CAT Shank ANSI B5.50 with Side Lock End Mill DIN 1835B

APPLICATION:

- It can be applied for heavy cutting and milling process generally. □ 適用於重切削及一般銑削加工
- The cutting tools can be clamped precisely. Even it's worked in heavy cutting, it will not result in slipping on cutting tools. □ 刀具夾持確實，即使重切削亦不致造成刀具滑動

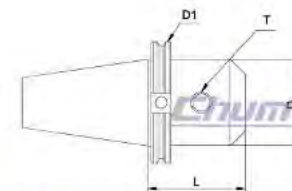

FIG. 1

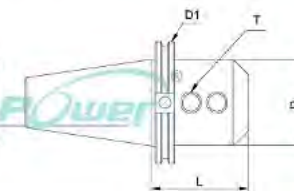

FIG. 2

INCH SIZE 英制

Code NO. 型號	TYPE 規格	L	D	D1	T	FIG. 圖
CT04010	CAT40xSLN1/8- 2.375	2.375	0.69	2.5	6#-32	1
CT04015	CAT40xSLN3/16- 2.5	2.5	0.69	2.5	8#-32	1
CT04020	CAT40xSLN1/4- 3	3	0.78	2.5	1/4-28	1
CT04025	CAT40xSLN5/16- 3	3	0.88	2.5	5/16-24	1
CT04030	CAT40xSLN3/8- 3	3	1	2.5	3/8-24	1
CT04035	CAT40xSLN1/2- 3	3	1.25	2.5	7/16-20	1
CT04040	CAT40xSLN5/8- 3	3	1.5	2.5	1/2-20	2
CT04045	CAT40xSLN3/4- 3	3	1.75	2.5	5/8-18	2
CT04050	CAT40xSLN7/8- 3.5	3.5	1.88	2.5	5/8-18	2
CT04055	CAT40xSLN1- 4	4	2	2.5	3/4-16	2
CT04060	CAT40xSLN1-1/4- 4.6	4.6	2.5	2.5	3/4-16	2
CT04065	CAT40xSLN1-1/2- 4.5	4.5	2.5	2.5	3/4-16	2
CT04070	CAT50xSLN1/4- 4	4	0.78	3.875	1/4-28	1
CT04075	CAT50xSLN5/16- 4	4	0.88	3.875	5/16-24	1
CT04080	CAT50xSLN3/8- 4	4	1	3.875	3/8-24	1
CT04085	CAT50xSLN1/2- 4	4	1.25	3.875	7/16-20	1
CT04090	CAT50xSLN5/8- 4	4	1.5	3.875	1/2-20	1
CT04095	CAT50xSLN3/4- 4	4	1.75	3.875	5/8-18	1
CT04100	CAT50xSLN7/8- 4	4	1.88	3.875	5/8-18	2
CT04105	CAT50xSLN1- 4	4	2	3.875	3/4-16	2
CT04110	CAT50xSLN1-1/4- 4	4	2.5	3.875	3/4-16	2
CT04115	CAT50xSLN1-1/2- 4.6	4.6	2.5	3.875	3/4-16	2

*Custom-built products are available on request.

TOOLING SYSTEM

CAT FACE MILL HOLDER

CAT 面銑式立銑刀把

CAT Shank ANSI B5.50 with Face Mill DIN 6357

APPLICATION:

- The product can be applied for Face milling.
- 本產品適用於平面銑削加工

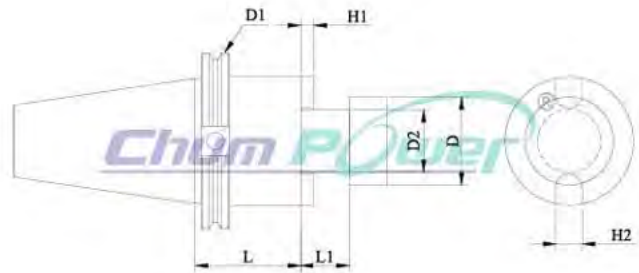

INCH SIZE 英制

Code NO. 型號	TYPE 規格	L	L1	D	D1	D2	H1	H2
CT06010	CAT40xFMA3/4-1.37	1.37	0.687	-	2.5	3/4	0.188	0.3125
CT06030	CAT40xFMA1-2.06	2.06	0.687	1.38	2.5	1	0.188	0.375
CT06045	CAT40xFMA1-1/4-2.21	2.21	0.687	1.61	2.5	1-1/4	0.25	0.5
CT06060	CAT40xFMA1-1/2-2.21	2.21	0.938	1.75	2.5	1-1/2	0.349	0.625
CT06070	CAT50xFMA3/4-1.5	1.5	0.687	-	3.875	3/4	0.188	0.3125
CT06085	CAT50xFMA1-2	2	0.687	1.38	3.875	1	0.188	0.375
CT06100	CAT50xFMA1-1/4-1.5	1.5	0.687	1.61	3.875	1-1/4	0.25	0.5
CT06120	CAT50xFMA1-1/2-2.4	2.4	0.938	1.75	3.875	1-1/2	0.349	0.625
CT06135	CAT50xFMA2-2.4	2.4	0.938	2.68	3.875	2	0.384	0.75

*Custom-built products are available on request.

SK CHU CNC DRILL CHUCK

SK 直結式鑽夾頭

SK Shank DIN 69871-A

FEATURES:

- 3 times better clamping capacity, comparing to keyed drill chucks.
- The drill bit won't be loosen or falling off.
- Twice precision than the keyed drill chucks.
- The drill chuck is interchangeable.

- 比普通夾頭多3倍的夾持力
- 鑽頭不會鬆動或掉落
- 比普通夾頭多出2倍精準
- 可替換式的夾頭

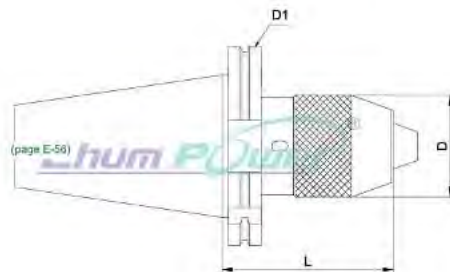

Code NO. 型號	TYPE 規格	L	D	D1	Spanner No. 扳手編號
SK01510	SK30xCHU8-80	80	37	50	12802
SK01520	SK30xCHU13-100	100	50		12806
SK01530	SK30xCHU16-125	125	57		12808
SK01540	SK40xCHU8-75	75	37	63.55	12802
SK01550	SK40xCHU13-100	100	50		12806
SK01560	SK40xCHU16-115	115	57		12808
SK01570	SK50xCHU13-100	100	50	97.5	12806
SK01580	SK50xCHU16-105	105	57		12808

*Custom-built products are available on request.

SK ER COLLET CHUCK

DIN 6499

SK 刀把 ER立銼式

SK Shank DIN 69871-A with Collet Chuck DIN 6499

APPLICATION:

- The product can be applied for end mills, drill bits reamers, taps, and can clamp any straight cutters and tools.
- 本產品可應用於銼刀,鑽頭,銹刀,絲攻及可夾持任何直柄的刀具及工具

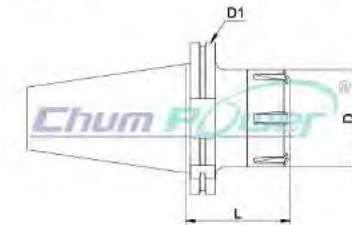

Code NO. 型號	TYPE 規格	L	D	D1	Spanner No. 扳手編號
SK02005	SK30xER11-80	80	19	50	80072-01
SK02010	SK30xER16-60	60	28		80072-02
SK02020	SK30xER20-60	60	34		80072-03
SK02030	SK30xER25-60	60	42		80072-04
SK02035	SK30xER32-60	60	50		80072-05
SK02040	SK40xER11-80	80	19	63.55	80072-01
SK02050	SK40xER16-70	70	28		80072-02
SK02075	SK40xER20-70	70	34		80072-03
SK02095	SK40xER25-70	70	42		80072-04
SK02120	SK40xER32-60	60	50		80072-05
SK02140	SK40xER40-80	80	63	97.5	80072-06
SK02155	SK40xER50-100	100	78		80072-07
SK02160	SK50xER16-100	100	28		80072-02
SK02180	SK50xER20-100	100	34	97.5	80072-03
SK02195	SK50xER25-70	70	42		80072-04
SK02215	SK50xER32-70	70	50		80072-05
SK02235	SK50xER40-70	70	63		80072-06
SK02255	SK50xER50-80	80	78		80076-07

*Custom-built products are available on request.



SK MILLING CHUCK

SK 強力式立銼刀把

SK Shank DIN 69871-A

FEATURES:

- It is designed with inner rolling needles inside. This design can reduce the friction resistance when tightening and the wear of parts.
- The design of dustproof can prevent iron scrap dropping and extend longevity of chuck.
- The high clamping force is available. The product can prevent the cutting tools from slipping when the users worked it and increase the longevity of cutting tools.
- High rigidity
- High precision

特性

- 內部滾針設計，可減少鎖緊時之摩擦阻力及零件磨耗。
- 防塵設計減少鐵屑掉入以延長使用壽命。
- 高夾持力，防止刀具於加工時滑脫，增加刀具壽命。
- 高剛性
- 高精度

APPLICATION:

- The Milling chuck can be applied for heavy-duty & higher accuracy cutting.
- 此強力銼刀把適用重型及高精密切削。

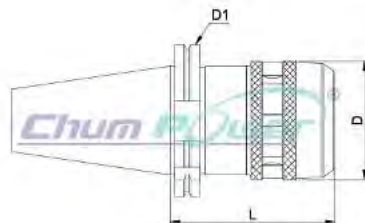

Code NO. 型號	TYPE 規格	L	D	D1	Spanner No. 扳手編號
SK03005	SK30xC20- 85	85	52	50	80200-05
SK03015	SK40xC20- 85	85	52	63.55	80200-05
SK03030	SK40xC32- 105	105	69		80200-15
SK03040	SK50xC20- 105	105	52	97.5	80200-05
SK03050	SK50xC32- 110	110	69		80200-15
SK03060	SK50xC42- 110	110	86		80200-20

*Custom-built products are available on request.



SK SIDE LOCK END MILL HOLDER

SK 側固式立銼刀把

SK Shank DIN 69871-A with Side Lock End Mill DIN 18358

APPLICATION:

- It can be applied for heavy cutting and milling process generally. 適用於重切削及一般銼削加工
- The cutting tools can be clamped precisely. Even it's worked in heavy cutting, it will not result in slipping on cutting tools. 刀具夾持確實，即使重切削亦不致造成刀具滑動

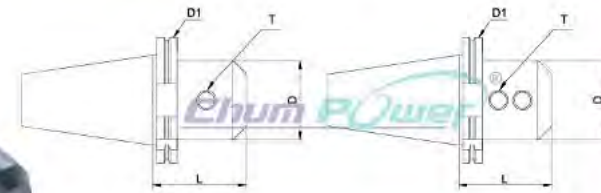

FIG. 1

FIG. 2

Code NO. 型號	TYPE 規格	L	D	D1	T	FIG.
SK04005	SK30xSLN6- 50	50	25	50	M6	1
SK04010	SK30xSLN8- 50	50	28	50	M8	1
SK04015	SK30xSLN10- 50	50	35	50	M10	1
SK04020	SK30xSLN12- 50	50	42	50	M12	1
SK04025	SK30xSLN16- 63	63	48	50	M14	1
SK04030	SK40xSLN6- 50	50	25	63.55	M6	1
SK04035	SK40xSLN8- 50	50	28	63.55	M8	1
SK04040	SK40xSLN10- 50	50	35	63.55	M10	1
SK04045	SK40xSLN12- 50	50	42	63.55	M12	1
SK04050	SK40xSLN16- 63	63	48	63.55	M14	1
SK04055	SK40xSLN20- 63	63	52	63.55	M16	1
SK04060	SK40xSLN25- 100	100	65	63.55	M18	2
SK04065	SK40xSLN32- 100	100	72	63.55	M20	2
SK04070	SK50xSLN6- 63	63	25	97.5	M6	1
SK04075	SK50xSLN8- 63	63	28	97.5	M8	1
SK04080	SK50xSLN10- 63	63	35	97.5	M10	1
SK04085	SK50xSLN12- 63	63	42	97.5	M12	1
SK04090	SK50xSLN16- 63	63	48	97.5	M14	1
SK04095	SK50xSLN20- 63	63	52	97.5	M16	1
SK04100	SK50xSLN25- 80	80	65	97.5	M18	2
SK04105	SK50xSLN32- 100	100	72	97.5	M20	2
SK04110	SK50xSLN40- 100	100	90	97.5	M20	2
SK04115	SK50xSLN42- 100	100	90	97.5	M20	2
SK04120	SK50xSLN50- 125	125	100	97.5	M24	2
SK04125	SK50xSLN63- 150	150	125	97.5	M24	2

*Custom-built products are available on request.

TOOLING SYSTEM

SK FACE MILL HOLDER

SK 面銑式立銑刀把

SK Shank DIN 69871-A with Face Mill DIN 6357

APPLICATION:

- The product can be applied for Face milling.
- 本產品適用於平面銑削加工

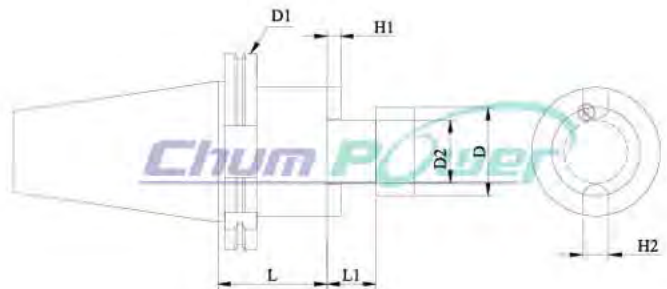

E-25

Code NO. 型號	TYPE 規格	L	L1	D	D1	D2	H1	H2
SK06005	SK30xFMB22- 35	35	18	26	50	22	4.8	10
SK06010	SK30xFMB27- 35	35	20	35	50	27	5.8	12
SK06015	SK40xFMB22- 35	35	18	26	63.55	22	4.8	10
SK06020	SK40xFMB27- 60	60	20	35	63.55	27	5.8	12
SK06025	SK40xFMB32- 60	60	22	41	63.55	32	6.8	14
SK06030	SK40xFMB40- 60	60	25	48	63.55	40	8.3	16
SK06035	SK50xFMB22- 35	35	18	26	97.5	22	4.8	10
SK06040	SK50xFMB27- 35	35	20	35	97.5	27	5.8	12
SK06045	SK50xFMB32- 35	35	22	41	97.5	32	6.8	14
SK06050	SK50xFMB40- 50	50	25	48	97.5	40	8.3	16
SK06055	SK50xFMB50- 60	60	30	68	97.5	50	9.7	19
SK06060	SK40xFMB40F- 60	60	26	-	63.55	40	8.3	16
SK06065	SK50xFMB40F- 70	70	26	-	97.5	40	8.3	16
SK06070	SK50xFMB60F- 70	70	25	-	97.5	60	12.5	25.4
SK06075	SK40xFS40- 60	60	26	-	63.55	40	8.3	16
SK06085	SK50xFS60- 70	70	25	-	97.5	60	12.5	25.4

*Custom-built products are available on request.

HSK CHU CNC DRILL CHUCKS

HSK 直結式鑽夾頭

HSK Shank DIN 69893-1A

FEATURES:

- 3 times better clamping capacity, comparing to keyed drill chucks.
- The drill bit won't be loosen or falling off.
- Twice precision than the keyed drill chucks.
- The drill chuck is interchangeable.

- 比普通夾頭多3倍的夾持力
- 鑽頭不會鬆脫或掉落
- 比普通夾頭多出2倍精準
- 可替換式的夾頭

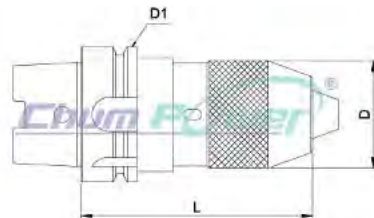

Code NO. 型號	TYPE 規格	L	D	D1	Spanner No. 扳手編號
HK01510	HSK50AxCHU13-110	110	50	50	12806
HK01520	HSK63AxCHU13-145	145	50	63	12806
HK01530	HSK100AxCHU13-120	120	50	100	12806

*Custom-built products are available on request.

HSK ER COLLET CHUCKS

HSK刀把 ER立銑式

HSK Shank DIN 69893-1A with Collet Chuck DIN 6499

APPLICATION:

- The product can be applied for end mills, drill bits, drill reamers, taps, and can clamp any straight cutters and tools.
- The product matches HSK BBT system (Big+Plus). It can increase the stability on the side direction processing.
- 本產品可應用於銼刀, 鑽頭, 銼刀, 絲攻及可夾持任何直式的刀具及工具
- 搭配HSK兩面拘束, 可增加側向加工的穩定性。

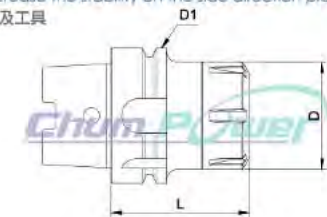

Code NO. 型號	TYPE 規格	L	D	D1	Spanner No. 扳手編號
HK02011	HSK40AxER20- 80	80	34	40	80072-03
HK02015	HSK40AxER25- 80	80	42	40	80072-04
HK02020	HSK50AxER16- 80	80	28	50	80072-02
HK02035	HSK50AxER20- 80	80	34	50	80072-03
HK02050	HSK50AxER25- 80	80	42	50	80072-04
HK02065	HSK50AxER32- 100	100	50	50	80072-05
HK02080	HSK63AxER16- 80	80	28	63	80072-02
HK02100	HSK63AxER20- 80	80	34	63	80072-03
HK02120	HSK63AxER25- 80	80	42	63	80072-04
HK02140	HSK63AxER32- 80	80	50	63	80072-05
HK02165	HSK63AxER40- 80	80	63	63	80072-06
HK02190	HSK63AxER50- 120	120	78	63	80072-07

*Custom-built products are available on request.



HSK ER COLLET CHUCKS

HSK刀把 ER立銑式

HSK Shank DIN 69893-1A with Collet Chuck DIN 6499

APPLICATION:

- The product can be applied for end mills, drill bits, drill reamers, taps, and can clamp any straight cutters and tools.
- The product matches HSK BBT system (Big+Plus), it can increase the stability on the side direction processing.
- 本產品可應用於銑刀, 鑽頭, 鉸刀, 絲攻及可夾持任何直式的刀具及工具
- 搭配HSK兩面拘束, 可增加側向加工的穩定性。

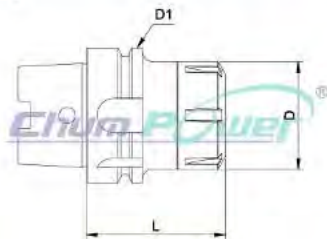

Code NO. 型號	TYPE 規格	L	D	D1	Spanner No. 扳手編號
HK02195	HSK100AxER16- 80	80	28	100	80072-02
HK02210	HSK100AxER20- 80	80	34	100	80072-03
HK02225	HSK100AxER25- 100	100	42	100	80072-04
HK02235	HSK100AxER32- 100	100	50	100	80072-05
HK02250	HSK100AxER40- 100	100	63	100	80072-06
HK02265	HSK100AxER50- 100	100	78	100	80072-07

*Custom-built products are available on request.



HSK MILLING CHUCKS

HSK強力式立銑刀把

HSK Shank DIN 69893-1A

FEATURES:

- It is designed with inner rolling needles inside. This design can reduce the friction resistance when tightening and the wear of parts.
- The design of dustproof can prevent iron scrap dropping and extend longevity of chuck.
- The high clamping force is available. The product can prevent the cutting tools from slipping when the users worked it and increase the longevity of cutting tools.
- High rigidity
- High precision

特性

- 內部滾針設計, 可減少鎖緊時之摩擦阻力及零件磨耗。
- 防塵設計減少鐵屑掉入以延長使用壽命。
- 高夾持力, 防止刀具於加工時滑脫, 增加刀具壽命
- 高剛性
- 高精密

APPLICATION:

- The Milling chuck can be applied for heavy-duty & higher accuracy cutting.
- The product matches HSK BBT system (Big+Plus). It can increase the stability on the side direction processing.
- 此強力銑刀把適用重型及高精密切削
- 搭配HSK兩面拘束, 可增加側向加工的穩定性。

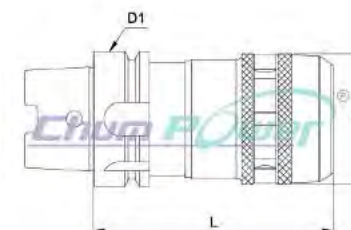

Code NO. 型號	TYPE 規格	L	D	D1	Spanner No. 扳手編號
HK03010	HSK50AxC20- 120	120	52	50	80200-05
HK03015	HSK63AxC20- 90	90	52	63	80200-05
HK03030	HSK63AxC32- 120	120	69	63	80200-15
HK03040	HSK63AxC42- 120	120	86	63	80200-20

*Custom-built products are available on request.



HSK SIDE LOCK END MILL HOLDER

HSK 側固式立銑刀把

HSK Shank DIN 69893-1A with Side Lock End Mill DIN 18358

APPLICATION:

- It can be applied for heavy cutting and milling process generally. □ 適用於重切削及一般銑削加工
- The cutting tools can be clamped precisely. Even if's worked in heavy cutting, it will not result in slipping on cutting tools. □ 刀具夾持確實，即使重切削亦不致造成刀具滑動
- The product matches HSK BBT system (Big+Plus). It can increase the stability on the side direction processing. □ 搭配HSK兩面拘束，可增加側向加工的穩定性。

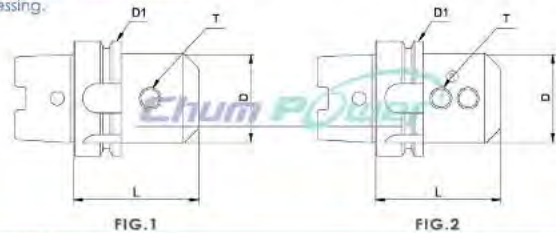

Code NO. 型號	TYPE 規格	L	D	D1	T	FIG. 圖
HK04015	HSK50AxSLN6- 65	65	25	50	M6	1
HK04025	HSK50AxSLN8- 65	65	28	50	M8	1
HK04035	HSK50AxSLN10- 65	65	35	50	M10	1
HK04045	HSK50AxSLN12- 80	80	42	50	M12	1
HK04050	HSK50AxSLN14- 80	80	44	50	M12	1
HK04055	HSK50AxSLN16- 80	80	48	50	M14	1
HK04065	HSK50AxSLN18- 80	80	50	50	M14	1
HK04070	HSK50AxSLN20- 80	80	52	50	M16	1
HK04080	HSK63AxSLN6- 65	65	25	63	M6	1
HK04090	HSK63AxSLN8- 65	65	28	63	M8	1
HK04100	HSK63AxSLN10- 65	65	35	63	M10	1
HK04110	HSK63AxSLN12- 80	80	42	63	M12	1
HK04115	HSK63AxSLN14- 80	80	44	63	M12	1
HK04120	HSK63AxSLN16- 80	80	48	63	M14	1
HK04130	HSK63AxSLN18- 80	80	50	63	M14	1
HK04145	HSK63AxSLN25- 110	110	65	63	M18	2
HK04150	HSK63AxSLN32- 110	110	72	63	M20	2
HK04155	HSK100AxSLN6- 80	80	25	100	M6	1
HK04160	HSK100AxSLN8- 80	80	28	100	M8	1
HK04165	HSK100AxSLN10- 80	80	35	100	M10	1
HK04170	HSK100AxSLN12- 80	80	42	100	M12	1
HK04175	HSK100AxSLN14- 80	80	44	100	M12	1
HK04180	HSK100AxSLN16- 100	100	48	100	M14	1
HK04185	HSK100AxSLN18- 100	100	50	100	M14	1
HK04190	HSK100AxSLN20- 100	100	52	100	M16	1
HK04195	HSK100AxSLN25- 100	100	65	100	M18	2
HK04200	HSK100AxSLN32- 100	100	72	100	M20	2
HK04205	HSK100AxSLN40- 120	120	90	100	M20	2

*Custom-built products are available on request.

HSK SIDE LOCK END MILL HOLDER

HSK 側固式立銑刀把

HSK Shank DIN 69893-1A with Side Lock End Mill DIN 18358

APPLICATION:

- It can be applied for heavy cutting and milling process generally. □ 適用於重切削及一般銑削加工
- The cutting tools can be clamped precisely. Even if's worked in heavy cutting, it will not result in slipping on cutting tools. □ 刀具夾持確實，即使重切削亦不致造成刀具滑動
- The product matches HSK BBT system (Big+Plus). It can increase the stability on the side direction processing. □ 搭配HSK兩面拘束，可增加側向加工的穩定性。

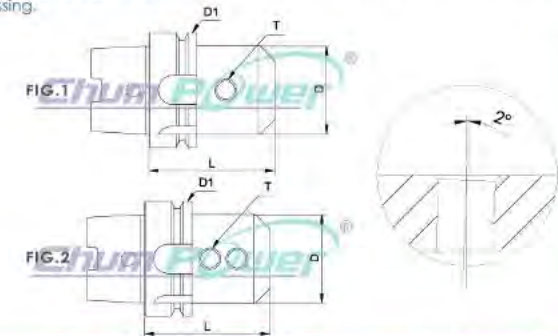

Code NO. 型號	TYPE 規格	L	D	D1	T	FIG. 圖
HK04210	HSK50AxSLNB6- 80	80	25	50	M6	1
HK04215	HSK50AxSLNB8- 80	80	28	50	M8	1
HK04220	HSK50AxSLNB10- 80	80	35	50	M10	1
HK04225	HSK50AxSLNB12- 90	90	42	50	M12	1
HK04230	HSK50AxSLNB14- 90	90	44	50	M12	1
HK04235	HSK50AxSLNB16- 90	90	48	50	M14	1
HK04240	HSK50AxSLNB18- 90	90	50	50	M14	1
HK04245	HSK50AxSLNB20- 100	100	52	50	M16	1
HK04250	HSK63AxSLNB6- 80	80	25	63	M6	1
HK04255	HSK63AxSLNB8- 80	80	28	63	M8	1
HK04260	HSK63AxSLNB10- 80	80	35	63	M10	1
HK04265	HSK63AxSLNB12- 90	90	42	63	M12	1
HK04270	HSK63AxSLNB14- 90	90	44	63	M12	1
HK04275	HSK63AxSLNB16- 100	100	48	63	M14	1
HK04280	HSK63AxSLNB18- 100	100	50	63	M14	1
HK04285	HSK63AxSLNB20- 100	100	52	63	M16	1
HK04290	HSK63AxSLNB25- 110	110	65	63	M18	2
HK04295	HSK63AxSLNB32- 110	110	72	63	M20	2
HK04300	HSK100AxSLNB6- 90	90	25	100	M6	1
HK04305	HSK100AxSLNB8- 90	90	28	100	M8	1
HK04310	HSK100AxSLNB10- 90	90	35	100	M10	1
HK04315	HSK100AxSLNB12- 100	100	42	100	M12	1
HK04320	HSK100AxSLNB14- 100	100	44	100	M12	1
HK04325	HSK100AxSLNB16- 100	100	48	100	M14	1
HK04330	HSK100AxSLNB18- 100	100	50	100	M14	1
HK04335	HSK100AxSLNB20- 110	110	52	100	M16	1
HK04340	HSK100AxSLNB25- 120	120	65	100	M18	2
HK04345	HSK100AxSLNB32- 120	120	72	100	M20	2
HK04350	HSK100AxSLNB40- 120	120	90	100	M20	2

*Custom-built products are available on request.

HSK FACE MILL HOLDER

HSK 面銑式立銑刀把

HSK Shank DIN 69893-1A with Face Mill DIN 6357

APPLICATION:

- The product can be applied for Face milling.
- The product matches HSK BBT system (Big+Plus). It can increase the stability on the side direction processing.
- 本產品適用於平面銑削加工
- 搭配HSK兩面拘束，可增加側向加工的穩定性。

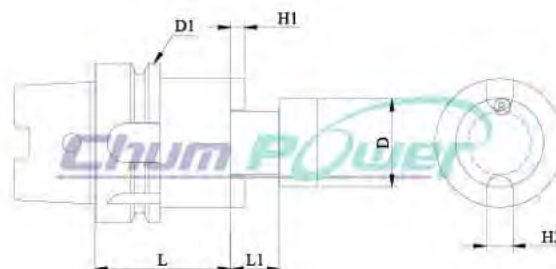

Code NO. 型號	TYPE 規格	L	L1	D	D1	D2	H1	H2
HK06010	HSK40AxFMB16- 50	50	17	-	40	16	3.8	8
HK06015	HSK40AxFMB22- 60	60	18	26	40	22	4.8	10
HK06020	HSK40AxFMB27- 60	60	20	35	40	27	5.8	12
HK06025	HSK40AxFMB32- 60	60	22	41	40	32	6.8	14
HK06035	HSK50AxFMB16- 50	50	17	-	50	16	3.8	8
HK06040	HSK50AxFMB22- 50	50	18	26	50	22	4.8	10
HK06055	HSK50AxFMB27- 60	60	20	35	50	27	5.8	12
HK06060	HSK50AxFMB32- 60	60	22	41	50	32	6.8	14
HK06065	HSK63AxFMB16- 50	50	17	-	63	16	3.8	8
HK06070	HSK63AxFMB22- 50	50	18	26	63	22	4.8	10
HK06080	HSK63AxFMB27- 60	60	20	35	63	27	5.8	12
HK06090	HSK63AxFMB32- 60	60	22	41	63	32	6.8	14
HK06095	HSK63AxFMB40- 60	60	25	48	63	40	8.3	16
HK06100	HSK100AxFMB22- 50	50	18	26	100	22	4.8	10
HK06105	HSK100AxFMB27- 50	50	20	35	100	27	5.8	12
HK06110	HSK100AxFMB32- 50	50	22	41	100	32	6.8	14
HK06115	HSK100AxFMB40- 70	60	25	48	100	40	8.3	16
HK06120	HSK100AxFMB50- 70	70	30	68	100	50	9.7	19
HK06125	HSK100AxFMB60- 70	70	40	-	100	60	9.7	19

*Custom-built products are available on request.

BT Hex Key Drill Chuck

BT 齒輪式夾頭

MAS 403 (JIS B 6339)

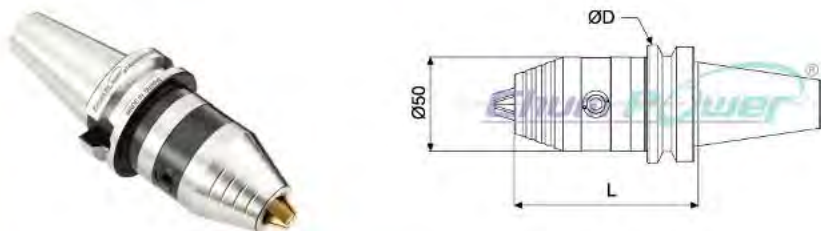

Code NO. 型號	Type 規格	夾持量 mm	Capacity Inch	L	ØD
BT22518	BT40xGHK13-98	0.3-13	3/64-1/2	98	63
BT22520	BT40xGHK16-103	1.5-16	1/16-5/8	103	63
BT22550	BT50xGHK13-109	0.3-13	3/64-1/2	109	100
BT22560	BT50xGHK16-114	1.5-16	1/16-5/8	114	100

*Custom-built products are available on request.

SK Hex Key Drill Chuck

SK 齒輪式夾頭

DIN 69871

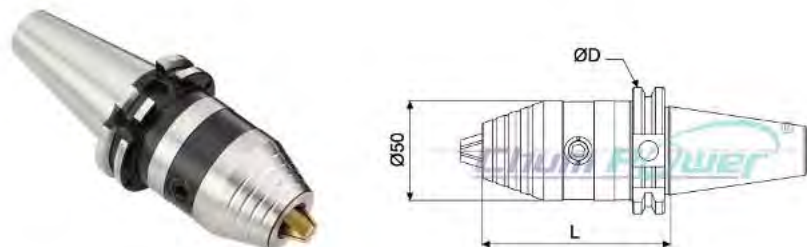

Code NO. 型號	Type 規格	夾持量 mm	Capacity Inch	L	ØD
SK22520	SK40xGHK13-90	0.3-13	3/64-1/2	90	63.55
SK22530	SK40xGHK16-95	1.5-16	1/16-5/8	95	63.55
SK22550	SK50xGHK13-90	0.3-13	3/64-1/2	90	97.5
SK22560	SK50xGHK16-95	1.5-16	1/16-5/8	95	97.5

*Custom-built products are available on request.

HSK Hex Key Drill Chuck

HSK 齒輪式夾頭

DIN 69893

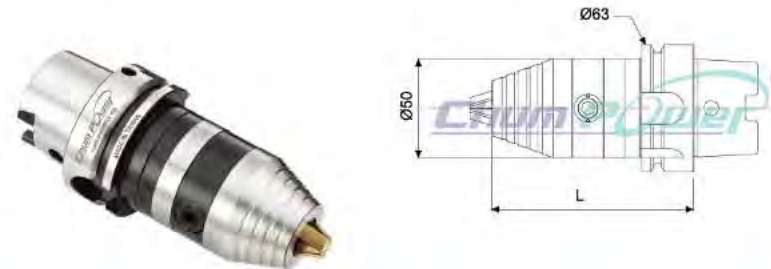

Code NO. 型號	Type 規格	夾持量 mm	Capacity Inch	L
HK22526	HSK63AxGHK13-105	0.3-13	3/64-1/2	105
HK22528	HSK63AxGHK16-110	1.5-16	1/16-5/8	110

*Custom-built products are available on request.

VDI Hex Key Drill Chuck

VDI 齒輪式夾頭

DIN 69880-1



Code NO. 型號	Type 規格	夾持量 mm	Capacity Inch	L	ØD	h	ØD1
VD22533	VDI30xGHK13-93	0.3-13	3/64-1/2	93	68	28	30
VD22536	VDI30xGHK16-98	1.5-16	1/16-5/8	98	68	28	30
VD22542	VDI40xGHK13-93	0.3-13	3/64-1/2	93	83	32	40
VD22545	VDI40xGHK16-98	1.5-16	1/16-5/8	98	83	32	40

*Custom-built products are available on request.

HEX KEY DRILL CHUCKS Arbor Type

MT (Morse Taper)

APPLICATION:

Arbor structure makes its performance perfect for drilling press and machine center. Fine components ensure the tolerance and accuracy well. The benefit of titanium jaws is to increase the intensity and wear-resistance.

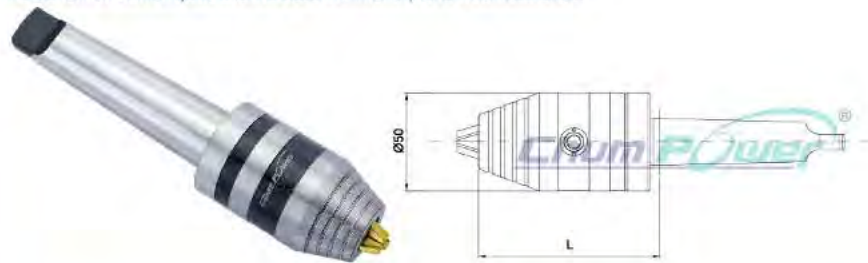

Code NO. 型號	Type 規格	夾持量 mm	Capacity Inch	L
MT22505	MT3xGHK13-88	0.3-13	1/64-1/2	88
MT22508	MT3xGHK16-93	1.5-16	1/16-5/8	93
MT22510	MT4xGHK13-89	0.3-13	1/64-1/2	89
MT22513	MT4xGHK16-94	1.5-16	1/16-5/8	94

*Custom-built products are available on request

HEX KEY DRILL CHUCKS Arbor Type

D (Straight Shank)

APPLICATION:

Arbor structure makes its performance perfect for drilling press and machine center. Fine components ensure the tolerance and accuracy well. The benefit of titanium jaws is to increase the intensity and wear-resistance.

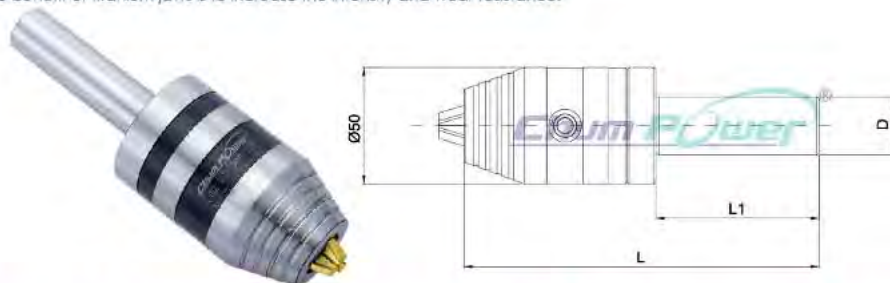

Code NO. 型號	Type 規格	夾持量 mm	Capacity Inch	L	L1	ØD
DD22515	D20xGHK13-152	0.3-13	1/64-1/2	152	70	20
DD22518	D20xGHK16-157	1.5-16	1/16-5/8	157	70	20
DD22525	D25xGHK13-152	0.3-13	1/64-1/2	152	70	25
DD22528	D25xGHK16-157	1.5-16	1/16-5/8	157	70	25
DD22535	D32xGHK13-152	0.3-13	1/64-1/2	152	70	32
DD22538	D32xGHK16-157	1.5-16	1/16-5/8	157	70	32

*Custom-built products are available on request

Coolant Pipe

冷卻導管

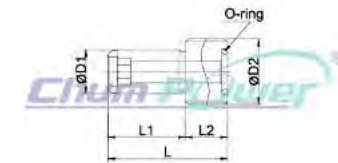

Code NO. 型號	HSK NO.	ØD1	ØD2	L	L1	L2	O-ring
84652	HSK32	6	M10x1.0	26	20.5	5.5	P4
84654	HSK40	8	M12x1.0	29.5	22	7.5	P6
84656	HSK50	10	M16x1.0	33	23.5	9.5	P9
84658	HSK63	12	M18x1.0	36.5	25	11.5	P11
84660	HSK80	14	M20x1.5	40	25.5	13.5	P12
84662	HSK100	16	M24x1.5	44	28.5	15.5	P15

BT/Coolant Thru-Hole Models

Pull Stud 拉栓

BT 水孔型

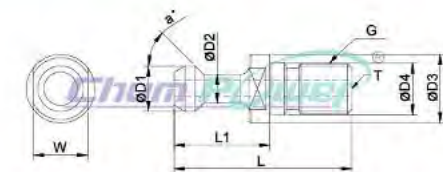

Code NO. 型號	TYPE BT-α 規格	T	W	L	L1	ØD1	ØD2	ØD3	ØD4	G
81210	BT40-45°	Ø4								
81211	BT40-60°	Ø4	19	60	35	15	10	23	17	M16
81212	BT40-90°	Ø4								
81268	BT50-45°	Ø7								
81269	BT50-60°	Ø7	30	85	45	23	17	38	25	M24
81270	BT50-90°	Ø7								

BT/Threading Ground Models

Pull Stud 拉栓

BT 磨牙型

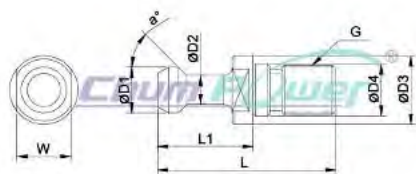

Code NO. 型號	TYPE (BT- α° G) 規格	W	L	L1	$\phi D1$	$\phi D2$	$\phi D3$	$\phi D4$	$\phi D5$	G
81242	BT30-45°G	13	43	23	11	7	16.5	12.5	M12	
81245	BT40-45°G	19	60	35	15	10	23	17	M16	
81244	BT50-45°G	30	85	45	23	17	38	25	M24	
81243	BT30-60°G	13	43	23	11	7	16.5	12.5	M12	
81246	BT40-60°G	19	60	35	15	10	23	17	M16	
81247	BT50-60°G	30	85	45	23	17	38	25	M24	
81248	BT30-90°G	13	43	23	11	7	16.5	12.5	M12	
81249	BT40-90°G	19	60	35	15	10	23	17	M16	
81250	BT50-90°G	30	85	45	23	17	38	25	M24	

DIN A Type

Pull Stud 拉栓

DIN A型

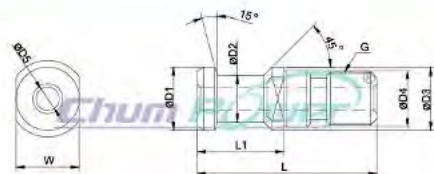

Code NO. 型號	TYPE 規格	W	L	L1	$\phi D1$	$\phi D2$	$\phi D3$	$\phi D4$	$\phi D5$	G
81251	DIN 30A	14	44	24	13	9	17	13	-	M12
81252	DIN 40A	19	54	26	19	14	23	17	7	M16
81253	DIN 40-A-L	19	54	29	19	14	23	17	7	M16
81254	DIN 50A	30	74	34	28	21	36	25	11.5	M24

DIN B Type

Pull Stud 拉栓

DIN B型

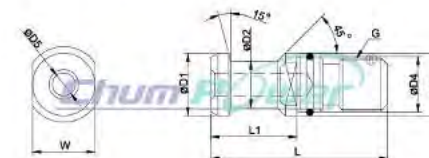

Code NO. 型號	TYPE 規格	W	L	L1	$\phi D1$	$\phi D2$	$\phi D3$	$\phi D4$	$\phi D5$	G
81255	DIN 30B	14	44	24	13	9	17	13	-	M12
81256	DIN 40B	19	54	26	19	14	23	17	7	M16
81257	DIN 50B	30	74	34	28	21	36	25	11.5	M24

DIN / R Type

Pull Stud 拉栓

DIN R型

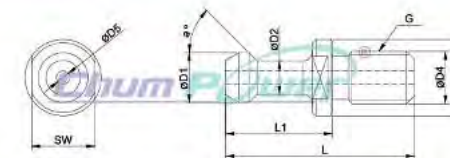

Code NO. 型號	TYPE 規格	SW	L	L1	$\phi D1$	$\phi D2$	$\phi D3$	$\phi D4$	$\phi D5$	G
81258	DIN 40-R	19	57	32	15	10	23	16	4	M16*P2.0

ISO A Type / ISO B Type

ISO A型 / ISO B型

Pull Stud 拉柱

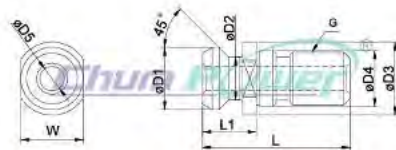

Code NO. 型號	TYPE 規格	W	L	L1	eD1	eD2	eD3	eD4	eD5	G
81259	ISO 40-A	19	54	26	19	14	23	17	7	M16
81260	ISO 50-A	30	74	34	28	21	36	25	11.5	M24
81261	ISO 40-B	19	44.5	16.4	18.8	12.95	22.5	17	7.3	M16
81262	ISO 50-B	30	65.5	25.5	29.1	19.6	37	25	11.5	M24

CAT Standard Models

CAT 標準型

Pull Stud 拉柱

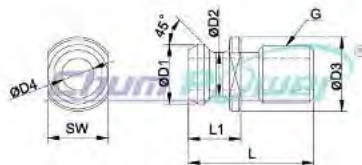

Code NO. 型號	TYPE 規格	SW	L	L1	eD1	eD2	eD3	eD4	G
81263	CAT 40	0.75	1.5	0.64	0.74	0.49	0.94	0.281	5/8"-11
81264	CAT 50	1.25	2.3	1	1.14	0.82	1.44	0.468	1"-8

ER SPRING COLLET SYSTEM

彈性筒夾

APPLICATION:

- It is applied for a variety of processing including drilling, milling, tapping and grinding.
- 它適用於各種的加工，包含鑽孔、銑床、攻牙和研磨

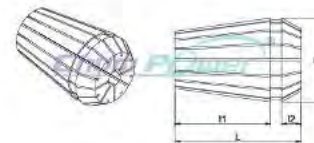

※Toolholder not included
不含刀把

Code NO. 型號	TYPE 規格	Collect 筒夾	D	L	I1	I2
80001	ER8x9	5, 4.5, 4, 3.5, 3, 2.5, 2, 1.5, 1	8.5	13.5	10.8	1.5
80002	ER11x7	7, 6, 5, 4, 3, 2, 1	11.5	18	13.5	2.5
80003	ER11x13	7, 6.5, 6, 5.5, 5, 4.5, 4, 3.5, 3, 2.5, 2, 1.5, 1	11.5	18	13.5	2.5
80004	ER16x8	10, 9, 8, 7, 6, 5, 4, 3	17	27	20.8	4
80005	ER16x10	10, 9, 8, 7, 6, 5, 4, 3, 2, 1	17	27	20.8	4
80006	ER20x10	13, 12, 11, 10, 9, 8, 7, 6, 5, 4	21	31	23.9	4.8
80007	ER20x12	13, 12, 11, 10, 9, 8, 7, 6, 5, 4, 3, 2	21	31	23.9	4.8
80008	ER25x7	16, 14, 12, 10, 8, 6, 4	26	35	25.9	5
80009	ER25x15	16, 15, 14, 13, 12, 11, 10, 9, 8, 7, 6, 5, 4, 3, 2	26	35	25.9	5
80010	ER32x6	20, 16, 12, 10, 8, 6	33	40	30.9	5.5
80011	ER32x11	20, 18, 16, 15, 13, 12, 10, 8, 6, 5, 4				
80014	ER32x18	20, 19, 18, 17, 16, 15, 14, 13, 12, 11, 10, 9, 8, 7, 6, 5, 4, 3	41	46	34.9	7
80013	ER40x7	25, 20, 16, 12, 10, 8, 6				
80015	ER40x15	26, 25, 22, 21, 20, 18, 16, 15, 13, 12, 10, 8, 6, 5, 4				
80016	ER40x23	26, 25, 24, 23, 22, 21, 20, 19, 18, 17, 16, 15, 14, 13, 12, 11, 10, 9, 8, 7, 6, 5, 4	52	60	46	8.5
80017	ER50x12	34, 32, 30, 28, 26, 24, 22, 20, 18, 16, 14, 12				

ER SPRING COLLET SYSTEM

彈性筒夾

APPLICATION:

- It is applied for a variety of processing including drilling, milling, tapping and grinding.
- 它適用於各種的加工, 包含鑽孔, 銑床, 攻牙和研磨



Code NO. 型號	TYPE 規格
80001-01	ER8(1.0-0.5)
80001-02	ER8(1.5-1.0)
80001-03	ER8(2.0-1.5)
80001-04	ER8(2.5-2.0)
80001-05	ER8(3.0-2.5)
80001-06	ER8(3.5-3.0)
80001-07	ER8(4.0-3.5)
80001-08	ER8(4.5-4.0)
80001-09	ER8(5.0-4.5)

Code NO. 型號	TYPE 規格
80005-01	ER16(1.0-0.5)
80005-02	ER16(1.5-1.0)
80005-03	ER16(2.0-1.5)
80005-04	ER16(2.5-2.0)
80005-05	ER16(3.0-2.5)
80005-06	ER16(3.5-3.0)
80005-07	ER16(4.0-3.5)
80005-08	ER16(4.5-4.0)
80005-09	ER16(5.0-4.5)
80005-10	ER16(5.5-5.0)
80005-12	ER16(6.0-5.5)
80005-20	ER16(6.5-6.0)
80005-14	ER16(7.0-6.5)
80005-15	ER16(7.5-7.0)
80005-16	ER16(8.0-7.5)
80005-17	ER16(8.5-8.0)
80005-18	ER16(9.0-8.5)
80005-19	ER16(9.5-9.0)
80005-13	ER16(10.0-9.5)

Code NO. 型號	TYPE 規格
80003-01	ER11(1.0-0.5)
80003-02	ER11(1.5-1.0)
80003-03	ER11(2.0-1.5)
80003-04	ER11(2.5-2.0)
80003-05	ER11(3.0-2.5)
80003-06	ER11(3.5-3.0)
80003-07	ER11(4.0-3.5)
80003-08	ER11(4.5-4.0)
80003-09	ER11(5.0-4.5)
80003-10	ER11(5.5-5.0)
80003-11	ER11(6.0-5.5)
80003-12	ER11(6.5-6.0)
80003-13	ER11(7.0-6.5)

Code NO. 型號	TYPE 規格
80009-02	ER25(2.0-1.0)
80009-03	ER25(3.0-2.0)
80009-04	ER25(4.0-3.0)
80009-05	ER25(5.0-4.0)
80009-06	ER25(6.0-5.0)
80009-07	ER25(7.0-6.0)
80009-13	ER25(8.0-7.0)
80009-14	ER25(9.0-8.0)
80009-15	ER25(10-9.0)
80009-16	ER25(11-10)
80009-17	ER25(12-11)
80009-18	ER25(13-12)
80009-19	ER25(14-13)
80009-20	ER25(15-14)
80009-21	ER25(16-15)

ER SPRING COLLET SYSTEM

彈性筒夾

APPLICATION:

- It is applied for a variety of processing including drilling, milling, tapping and grinding.
- 它適用於各種的加工, 包含鑽孔, 銑床, 攻牙和研磨



Code NO. 型號	TYPE 規格
80017-06	ER50(12-10)
80017-07	ER50(14-12)
80017-08	ER50(16-14)
80017-09	ER50(18-16)
80017-10	ER50(20-18)
80017-11	ER50(22-20)
80017-12	ER50(24-22)
80017-13	ER50(26-24)
80017-14	ER50(28-26)
80017-15	ER50(30-28)
80017-16	ER50(32-30)
80017-17	ER50(34-32)

Code NO. 型號	TYPE 規格
80007-17	ER20(1.0-0.5)
80007-01	ER20(1.5-1.0)
80007-02	ER20(2.0-1.5)
80007-03	ER20(2.5-2.0)
80007-04	ER20(3.0-2.5)
80007-05	ER20(3.5-3.0)
80007-06	ER20(4.0-3.5)
80007-07	ER20(4.5-4.0)
80007-08	ER20(5.0-4.5)
80007-09	ER20(5.5-5.0)
80007-10	ER20(6.0-5.5)
80007-11	ER20(6.5-6.0)
80007-12	ER20(7.0-6.5)
80007-13	ER20(7.5-7.0)
80007-14	ER20(8.0-7.5)
80007-15	ER20(8.5-8.0)
80007-16	ER20(9.0-8.5)
80007-18	ER20(9.5-9.0)
80007-19	ER20(10-9.5)
80007-20	ER20(10.5-10)
80007-21	ER20(11-10.5)
80007-22	ER20(11.5-11)
80007-23	ER20(12-11.5)
80007-24	ER20(12.5-12)
80007-25	ER20(13-12.5)

Code NO. 型號	TYPE 規格
80014-01	ER32(2.0-1.0)
80014-02	ER32(3.0-2.0)
80014-03	ER32(4.0-3.0)
80014-04	ER32(5.0-4.0)
80014-05	ER32(6.0-5.0)
80014-06	ER32(7.0-6.0)
80014-11	ER32(8.0-7.0)
80014-12	ER32(9.0-8.0)
80014-13	ER32(10-9.0)
80014-14	ER32(11-10)
80014-15	ER32(12-11)
80014-16	ER32(13-12)
80014-17	ER32(14-13)
80014-18	ER32(15-14)
80014-19	ER32(16-15)
80014-20	ER32(17-16)
80014-21	ER32(18-17)
80014-22	ER32(19-18)
80014-23	ER32(20-19)

Code NO. 型號	TYPE 規格
80016-01	ER40(3.0-2.0)
80016-02	ER40(4.0-3.0)
80016-03	ER40(5.0-4.0)
80016-04	ER40(6.0-5.0)
80016-05	ER40(7.0-6.0)
80016-06	ER40(8.0-7.0)
80016-11	ER40(9.0-8.0)
80016-12	ER40(10-9.0)
80016-13	ER40(11-10)
80016-14	ER40(12-11)
80016-15	ER40(13-12)
80016-16	ER40(14-13)
80016-17	ER40(15-14)
80016-18	ER40(16-15)
80016-19	ER40(17-16)
80016-20	ER40(18-17)
80016-21	ER40(19-18)
80016-22	ER40(20-19)
80016-23	ER40(21-20)
80016-24	ER40(22-21)
80016-25	ER40(23-22)
80016-26	ER40(24-23)
80016-27	ER40(25-24)
80016-28	ER40(26-25)

SK SPRING COLLET SYSTEM

彈性筒夾

APPLICATION:

- It is applied for a variety of processing including drilling, milling, tapping, mill.
- 它適用於各種的加工, 包含鑽孔, 銑床, 攻牙和銑刀

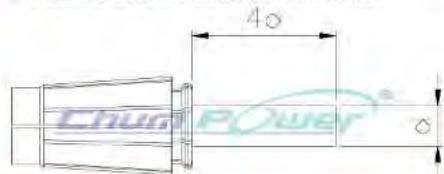

SK6			
Code No.	TYPE	φD	RANGE
80027-06	SK6	2.0	2~1.75
80027-08	SK6	2.5	2.5~2.25
80027-10	SK6	3.0	3~2.75
80027-11	SK6	3.5	3.5~3
80027-12	SK6	4.0	4~3.5
80027-13	SK6	4.5	4.5~4
80027-14	SK6	5.0	5~4.5
80027-15	SK6	5.5	5.5~5
80027-16	SK6	6.0	6~5.5

SK16			
Code No.	TYPE	φD	RANGE
80029-22	SK16	3	3~2.75
80029-02	SK16	3.5	3.5~3
80029-03	SK16	4	4~3.5
80029-04	SK16	4.5	4.5~4
80029-05	SK16	5	5~4.5
80029-06	SK16	5.5	5.5~5
80029-07	SK16	6	6~5.5
80029-08	SK16	6.5	6.5~6
80029-09	SK16	7	7~6.5
80029-10	SK16	7.5	7.5~7
80029-11	SK16	8	8~7.5
80029-12	SK16	8.5	8.5~8
80029-13	SK16	9	9~8.5
80029-14	SK16	9.5	9.5~9
80029-15	SK16	10	10~9.5
80029-16	SK16	10.5	10.5~10
80029-17	SK16	11	11~10.5
80029-18	SK16	11.5	11.5~11
80029-19	SK16	12	12~11.5
80029-23	SK16	12.5	12.5~12
80029-24	SK16	13	13~12.5
80029-25	SK16	13.5	13.5~13
80029-26	SK16	14	14~13.5
80029-27	SK16	14.5	14.5~14
80029-28	SK16	15	15~14.5
80029-29	SK16	15.5	15.5~15
80029-30	SK16	16	16~15.5

SK25			
Code No.	TYPE	φD	RANGE
80031-01	SK25	6.0	6~5.5
80031-02	SK25	8.0	8~7.5
80031-03	SK25	10.0	10~9.5
80031-04	SK25	12.0	12~11.5
80031-05	SK25	14.0	14~13.4
80031-06	SK25	16.0	16~15.5
80031-10	SK25	18.0	18~17.5
80031-14	SK25	20.0	20~19.5
80031-18	SK25	22.0	22~21.5
80031-22	SK25	24.0	24~23.5
80031-24	SK25	25.0	25~24.5
80031-25	SK25	25.4	25.4~25

SK10			
Code No.	TYPE	φD	RANGE
80028-01	SK10	2	2~1.75
80028-03	SK10	2.5	2.5~2.25
80028-05	SK10	3	3~2.75
80028-06	SK10	3.5	3.5~3
80028-07	SK10	4	4~3.5
80028-08	SK10	4.5	4.5~4
80028-09	SK10	5	5~4.5
80028-10	SK10	5.5	5.5~5
80028-11	SK10	6	6~5.5
80028-12	SK10	6.5	6.5~6
80028-13	SK10	7	7~6.5
80028-14	SK10	7.5	7.5~7
80028-15	SK10	8	8~7.5
80028-16	SK10	8.5	8.5~8
80028-17	SK10	9	9~8.5
80028-18	SK10	9.5	9.5~9
80028-19	SK10	10	10~9.5

SK20			
Code No.	TYPE	φD	RANGE
80030-01	SK20	3.0	3~2.75
80030-02	SK20	4.0	4~3.5
80030-04	SK20	5.0	5~4.5
80030-06	SK20	6	6~5.5
80030-07	SK20	6.5	6.5~6
80030-08	SK20	7	7~6.5
80030-09	SK20	7.5	7.5~7
80030-10	SK20	8	8~7.5
80030-11	SK20	8.5	8.5~8
80030-12	SK20	9	9~8.5
80030-13	SK20	9.5	9.5~9
80030-14	SK20	10	10~9.5
80030-15	SK20	10.5	10.5~10
80030-16	SK20	11	11~10.5
80030-17	SK20	11.5	11.5~11
80030-18	SK20	12	12~11.5
80030-19	SK20	12.5	12.5~12
80030-20	SK20	13	13~12.5
80030-21	SK20	13.5	13.5~13
80030-22	SK20	14	14~13.5
80030-23	SK20	14.5	14.5~14
80030-24	SK20	15	15~14.5
80030-25	SK20	15.5	15.5~15
80030-26	SK20	16	16~15.5
80030-27	SK20	16.5	16.5~16
80030-28	SK20	17	17~16.5
80030-29	SK20	17.5	17.5~17
80030-30	SK20	18	18~17.5
80030-31	SK20	18.5	18.5~18
80030-32	SK20	19	19~18.5
80030-33	SK20	19.5	19.5~19
80030-34	SK20	20	20~19.5

SLIM FIT COLLET

錐孔筒夾

APPLICATION:

- It is applied for a variety of processing including drilling, milling, tapping.
- 它適用於各種的加工, 包含鑽孔, 銑床, 攻牙

TAPE	D	L
SBL6	Ø14.7	62.4
SBL12	Ø17.8	64.2
SBL20	Ø26.1	69.9



Code NO.	型號	TYPE	規格	φD柄徑
80075-12	SBL6		Ø3	
80075-14	SBL6		Ø4	
80075-20	SBL6		Ø4.5	
80075-21	SBL6		Ø5.5	
80075-16	SBL6		Ø6	
80075-18	SBL6		Ø8	
80075-26	SBL6		Ø7/64"	
80075-27	SBL6		Ø1/8"	
80075-28	SBL6		Ø9/64"	
80075-29	SBL6		Ø11/64"	
80075-30	SBL6		Ø3/16"	
80075-31	SBL6		Ø13/64"	
80075-32	SBL6		Ø15/64"	
80075-33	SBL6		Ø1/4"	

Code NO.	型號	TYPE	規格	φD柄徑
80077-06	SBL12		Ø4	
80077-08	SBL12		Ø6	
80077-10	SBL12		Ø8	
80077-12	SBL12		Ø10	
80077-14	SBL12		Ø12	
80077-16	SBL12		Ø14	
80077-26	SBL12		Ø1/8"	
80077-27	SBL12		Ø3/16"	
80077-28	SBL12		Ø1/4"	
80077-29	SBL12		Ø5/16"	
80077-30	SBL12		Ø3/8"	

Code NO.	型號	TYPE	規格	φD柄徑
80079-02	SBL20		Ø6	
80079-04	SBL20		Ø8	
80079-06	SBL20		Ø10	
80079-08	SBL20		Ø12	
80079-10	SBL20		Ø14	
80079-12	SBL20		Ø16	
80079-13	SBL20		Ø18	
80079-14	SBL20		Ø20	
80079-26	SBL20		Ø1/8"	
80079-27	SBL20		Ø3/16"	
80079-28	SBL20		Ø1/4"	
80079-29	SBL20		Ø5/16"	
80079-30	SBL20		Ø3/8"	
80079-31	SBL20		Ø1/2"	
80079-32	SBL20		Ø5/8"	
80079-33	SBL20		Ø3/4"	

STRAIGHT COLLET

直筒式彈性筒夾

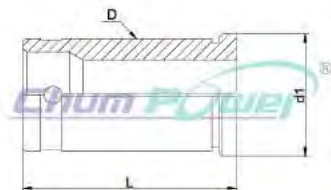

Code NO. 型號	TYPE 規格	L	D	d1
80049-02	C20-6	52	20	25
80049-04	C20-8			
80049-06	C20-10			
80049-08	C20-12			
80049-10	C20-14			
80049-12	C20-15			
80049-14	C20-16			

Code NO. 型號	TYPE 規格	L	D	d1
80050-02	C32-4	73	32	37
80050-04	C32-5			
80050-06	C32-6			
80050-08	C32-8			
80050-10	C32-10			
80050-12	C32-12			
80050-14	C32-14			
80050-16	C32-16			
80050-18	C32-18			
80050-20	C32-20			
80050-22	C32-22			
80050-24	C32-25			

STRAIGHT COLLET

直筒式彈性筒夾

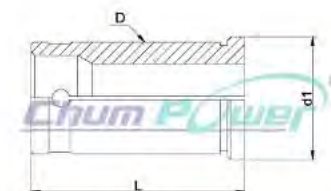

Code NO. 型號	TYPE 規格	L	D	d1
80051-06	C42-6	80	42	48
80051-08	C42-8			
80051-10	C42-10			
80051-12	C42-12			
80051-14	C42-14			
80051-16	C42-16			
80051-18	C42-18			
80051-20	C42-20			
80051-22	C42-22			
80051-24	C42-25			
80051-26	C42-32			

Code NO. 型號	TYPE 規格	L	D	d1
80052-02	C25-4	60	25	31
80052-04	C25-5			
80052-06	C25-6			
80052-08	C25-8			
80052-10	C25-10			
80052-12	C25-12			
80052-14	C25-14			
80052-16	C25-16			
80052-18	C25-18			
80052-20	C25-20			



ER Straight Collet Chuck

直柄ER刀桿

ST Collet DMV 2109



Code NO. 型號	TYPE 規格	L	LI	ØD	ØD1	
80950	ST1/2"-ER11-4"	0.825"	4"	19	1/2"	
80951	ST1/2"-ER11-6"		6"		1/2"	
80952	ST5/8"-ER11-4"		4"		5/8"	
80953	ST5/8"-ER11-6"		6"		5/8"	
80954	ST5/8"-ER16-4"	1.18"	2.5"	28	5/8"	
80956	ST3/4"-ER16-4"		6"		3/4"	
80957	ST3/4"-ER16-6"		4"		3/4"	
80959	ST1"-ER16-4"		4"		1"	
80960	ST1"-ER16-6"		4"		1"	
			6"		1"	
80961	ST3/4"-ER20-2.5"	1.42"	2.5"	34	3/4"	
80962	ST3/4"-ER20-4"		4"		3/4"	
80963	ST3/4"-ER20-6"		6"		3/4"	
80964	ST1"-ER20-2.5"		2.5"		1"	
80965	ST1"-ER20-4"		4"		1"	
80966	ST1"-ER20-6"		6"		1"	
80968	ST1"-ER25-4"		4"		1"	
80969	ST1"-ER25-6"		6"		1"	
80971	ST1 1/4"-ER32-4"		4"		1 1/4"	
80973	ST1 1/4"-ER40-3"	2.17"	3"	63	1 1/4"	
80520	ST16-ER11-50	21	50	19	16	
80521	ST16-ER11-100		100			
80522	ST16-ER11-140		140			
80523	ST16-ER16-100	30	100	28	16	
80524	ST20-ER16-60		60		20	
80525	ST20-ER16-100		100			
80526	ST20-ER16-150		150		25	
80527	ST25-ER16-100		100			
80528	ST25-ER16-150		150			
80529	ST20-ER20-50	36	60	34	20	
80530	ST20-ER20-100		100			
80531	ST20-ER20-150		150			
80532	ST25-ER20-60		60			25
80533	ST25-ER20-100		100			
80534	ST25-ER20-150		150			
80535	ST20-ER25-60	46	60	42	20	
80536	ST20-ER25-100		100			
80537	ST20-ER25-150		150			
80538	ST25-ER25-100		100			25
80539	ST25-ER25-150		150			
80540	ST32-ER25-60		60			
80541	ST20-ER32-60	54	60	50	20	
80542	ST25-ER32-80		80		25	
80543	ST32-ER32-100		100		32	
80544	ST32-ER32-150		150		40	
80545	ST40-ER32-100		100			

Code NO. 型號	TYPE 規格	L	LI	ØD	ØD1	
80546	ST32-ER40-100	55	100	63	32	
80547	ST40-ER40-100		100		40	
80981	ST16-ER11S-50	22	50	16	16	
80982	ST16-ER11S-100		100			
80983	ST16-ER11S-150		150			
80984	ST16-ER16S-100	32	100	22	20	
80985	ST20-ER16S-50		50			
80986	ST16-ER16S-100		100			
80987	ST20-ER16S-150		150			
80988	ST20-ER16S-200		200			
80989	ST25-ER16S-100		100			
80990	ST25-ER16S-150		150			25
80991	ST25-ER16S-200		200			
80992	ST20-ER20S-50		35			50
80993	ST20-ER20S-100	100				
80994	ST20-ER20S-150	150				
80995	ST20-ER20S-200	200				
80996	ST25-ER20S-100	100				
80997	ST25-ER20S-150	150				
80998	ST25-ER20S-200	200				

ER Straight Collet Chuck

直柄ER刀桿



Code NO. 型號	TYPE 規格	L	LI	ØD	ØD1
80581	ST16-ER11S-50	22	50	16	16
80582	ST16-ER11S-100		100		16
80583	ST16-ER11S-150		150		16
80584	ST16-ER16S-100	32	100	22	20
80585	ST20-ER16S-50		50		20
80586	ST20-ER16S-100		100		20
80587	ST20-ER16S-150		150		20
80588	ST20-ER16S-200		200		20
80589	ST25-ER16S-100		100		25
80590	ST25-ER16S-150		150		25
80591	ST25-ER16S-200		200		25
80592	ST20-ER20S-50		35		50
80593	ST20-ER20S-100	100		20	
80594	ST20-ER20S-150	150		20	
80595	ST20-ER20S-200	200		20	
80596	ST25-ER20S-100	100		25	
80597	ST25-ER20S-150	150		25	
80598	ST25-ER20S-200	200		25	

Z Axial Preset Gauge

Z軸設定器



Z Axial Preset Gauge

Z軸設定器

- For setting length on machining centers/lathe centers.
 - Setting height: 50.00 ± 0.005mm.
 - Large measuring surface and easy to operate.
 - Low spring force. May avoid the milling cutter or the drill bit breaking.
 - Easy to be calibrated by a ground parallel or gauge block.
 - Better parallelism, sensitivit, and precision for use.
- 在電腦銑床/車床上設定刀長用
 - 設計高度：50.00 ± 0.005mm
 - 量測面大，操作容易
 - 彈簧力較小，可避免小銑刀或鑽頭斷裂
 - 用研磨過的平行板，即可簡單設定
 - 平行度及各方面使用靈敏，且精度更好



Code NO. 型號	TYPE 規格	Height 高度 (mm)	G.W.Weight 重量 (KGS)	LxWxH 長X寬X高 (mm)	Magnetism 磁性
84551	ZH-50A	50.00 ± 0.005	1.2	50x63x63	○

Tool Holder Locking Device

鎖刀座



Tool Locking Device

鎖刀座

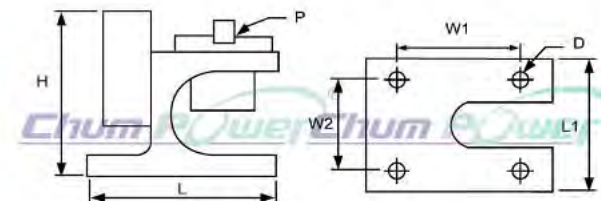

Code NO. 型號	TYPE 規格	F	L	L1	H	W1	W2	D	Weight 重量 (kg)
84510	BT30	BT	145	103	143	112	72	13	4.2
84511	BT40	BT	145	103	143	112	72	13	4.2
84512	BT50	BT	177	135	205	140	100	13	7.6
84516	CAT30	CAT	145	103	143	112	72	13	4.2
84517	CAT40	CAT	145	103	143	112	72	13	4.2
84518	CAT50	CAT	177	135	205	140	100	13	7.6

Tool Locking Device A Type (Cast Iron Body)

鎖刀座 A型 (主體為鑄鐵)

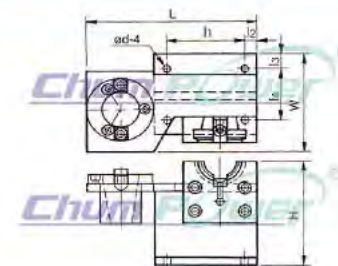

Code NO. 型號	TYPE 規格	L	l1	l2	l3	l4	H	W	N.W. 淨重 (kg)	G.W. 毛重 (kg)	Shipment Size 裝箱尺寸 (cm)
8451001	CP-BT30A	210	95	10	15	67	130	100	3.6	3.7	22x11.5x14
8451101	CP-BT40A	210	95	10	15	67	130	100	3.7	3.9	22x11.5x14
8451201	CP-BT50A	275	113	20	24	105	200	150	11.0	11.4	29.5x17x21
8452901	CP-DIN40A	210	95	10	15	67	130	100	3.6	3.8	22x11.5x14
8453001	CP-DIN50A	275	113	20	24	105	200	150	10.8	11.2	29.5x17x21
8451701	CP-CAT40A	210	95	10	15	67	130	100	3.6	3.8	22x11.5x14
8451801	CP-CAT50A	275	113	20	24	105	200	150	10.8	11.2	29.5x17x21

Optical Edge Finder

光電式尋邊器

- Quickly locate work edges and save time to find positions for Milling , Lathe Machine, and other machines.
- The scope of application includes processing material edge, and measuring inside and outside diameters of work-piece efficiently.
- There is a safety spring puller, which will put a ball precisely back to the position when ball breaks away from ball seat.
- Attached 2 dry batteries to light the red lamp.
- 迅速的找出工作位置，對於銑床、車床、及其他機械設備，都能有效率節省尋找位置所需時間。
- 可應用於加工件邊及內、外徑之高效率量測。
- 當鋼珠脫離時，有一個安全彈簧可精確的將其拉回原來的位置。
- 附2枚1.5V鹼性乾電池

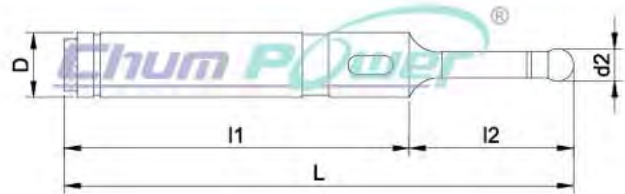

Code NO. 型號	TYPE D 規格	d2	L	l1	l2
84630	20	10	158	108	50
84631	32	10	158	108	50
84632	3/4"	0.4"	158	108	50
84633	1 1/4"	0.4"	158	108	50



ER Spanner

ER 板手

ER 小徑板手
ER S



Code NO. 型號	Spec. 規格	A	L
80072-08	ER8S	13	75
80072-09	ER11S	17	95
80072-10	ER16S	22.5	118
80072-11	ER20S	28	130
80072-12	ER25S	36.5	135

六角板手
ER Hex



Code NO. 型號	Spec. 規格	A	L
8007201-01	ER11H	17	130
8007200-02	ER16H	25	140
8007200-03	ER20H	30	170

ER標準板手
ER B



Code NO. 型號	Spec. 規格	A	L
8007200-04	ER25B	65	210
8007200-05	ER32B	75	250
8007201-06	ER40B	90	290
8007200-07	ER50B	110	350

Hook Wrench

勾板手



Code NO. 型號	Spec. 規格	A	L
8020000-05	C20	-	227
8020000-10	C25	-	227
8020000-15	C32	-	260
8020000-20	C42	-	270

NUT

螺帽

H Type



ER Hex

Code NO. 型號	Spec. 規格	H	D	G	Spanner No. 扳手編號
80071-01	ER 11-H	12	19	M14x0.75P	8007201-01
80071-02	ER 16-H	19	25	M22x1.5P	8007200-02
80071-03	ER 20-H	19	34	M25x1.5P	8007200-03

B Type



ER B

Code NO. 型號	Spec. 規格	H	D	G	Spanner No. 扳手編號
80071-04	ER 25-B	20	42	M32x1.5P	8007200-04
80071-05	ER 32-B	24	50	M40x1.5P	8007200-05
80071-06	ER 40-B	25	63	M50x1.5P	8007201-06
80071-07	ER 50-B	35	78	M64x2.0P	8007200-07

S Type



ER S

Code NO. 型號	Spec. 規格	H	D	G	Spanner No. 扳手編號
80071-08	ER 8-S	10.8	12	M10x0.75P	80072-08
80071-09	ER 11-S	12	16	M13x0.75P	80072-09
80071-10	ER 16-S	18	23	M19x1.0P	80072-10
80071-11	ER 20-S	19	28	M24x1.0P	80072-11
80071-12	ER 25-S	20	35	M30x1.0P	80072-12



Code NO. 型號	Spec. 規格	H	D	G	Spanner No. 扳手編號
80071-61	SK 6	16.5	19.5	M15xP1.0	80072-51
80071-58	SK10	20	30	M21.5xP1.0	80072-52
80071-60	SK16	30	40	M32xP1.5	80072-53



Code NO. 型號	Spec. 規格	H	D	SW	G	Spanner No. 扳手編號
80071-63	SK 6	10	19.5	17	M15xP1.0	-
80071-64	SK10	18	29	25	M21.5xP1.0	-
80071-55	SK16	24	40	36	M32xP1.5	-
80071-65	SK20	20	48.5	44	M40x1.5P	-
80071-66	SK25	22	55	53	M45x1.5P	-