

Vises System

虎鉗系統

F

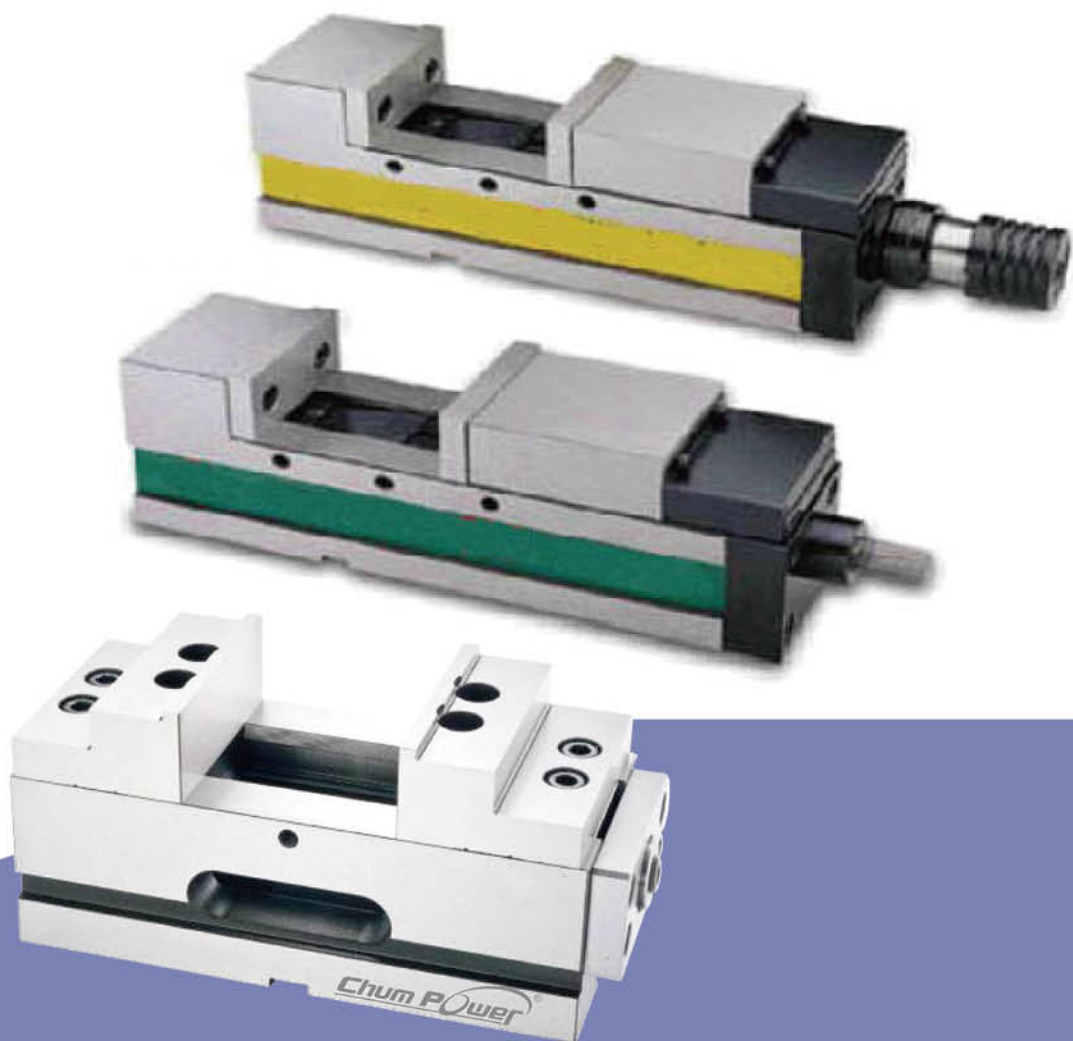

MC Hydraulic & Angle Lock Vise / MC Compact Vise

MODEL: HV

Feature / 特點

- One piece casting of vise bed and flexed jaw.
- Down thrust "Semis-sphere Segment" mechanism-eliminates jaw life and work tilt.
- Rigid material-vise body of ductile iron FCD60JIS (equal to GGG60) with 60 kgs/mm² or 80,000 psi tensile strength.
- Vise bed flame with harden treatment up to HRC 45° and up takes up wear and maintain for long.
- 本台及前端固定鉗口為一體成型鑄造，變形量少。
- 半圓球下壓角固機構可防止工件上浮並加強夾持緊度。
- 虎鉗材質使用球狀石墨鑄鐵 FCD60 (等同於 GGG60)，60 kgs/mm² 或 80,000 psi 高抗張拉力，不易變形。
- 滑軌經高週波熱處理 HRC 45°，可維持精度及延長耐磨。
- 同高定規格可搭配多台並列使用，適用於各式加工機作重切削及精密加工。
- 特殊虎口板可供選配。



Accuracy testing standard

NO	Item	JIS grade 1	Guaranteed
1	Vise side-lock on bottom slide way square.	0.020 100mm	0.010 100mm
2	Keyways on bottom of vise bed square to clamping surface of jaw plate.	0.020 100mm	0.015 100mm
3	Both jaw plate parallel.	0.020 100mm	0.020 100mm
4	Max opening test block parallel to bottom of vise body.	0.050 100mm	0.030 100mm
5	Top of rectangular test block clamped tightly by jaw parallel to bottom of vise body.	0.030 100mm	0.020 100mm
6	Surface of vise bed parallel to bottom of vise body.	0.020 100mm	0.015 100mm

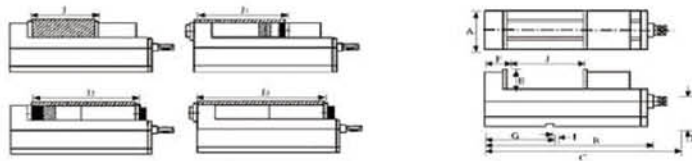
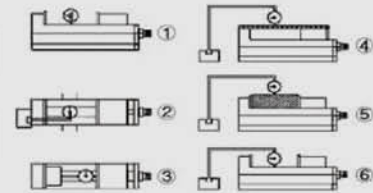

Hydraulic Type

Code NO. 型號	Spec. 規格	A	B	C	D	E	F	G	I	Jaw Opening(Max.)				Clamping Force	Weight Body
										J	J1	J2	J3		
BTCAS5100110	HV-100V	101	380	480	85	48	80	125	16	135	200	240	330	4000 KGF	27 KGS
BTCAS5100210	HV-130V	131	445	545	95	55	85	150	18	190	250	300	390	5000 KGF	40 KGS
BTCAS5100310	HV-160V	161	535	635	105	58	100	165	18	250	330	370	480	5500 KGF	58 KGS
BTCAS5100410	HV-160VL	161	585	685	105	58	100	165	18	300	380	420	530	5500 KGF	62 KGS
BTCAS5100510	HV-200V	201	610	710	110	63	108	190	18	300	370	430	550	6900 KGF	81 KGS

Mechanical Type

Code NO. 型號	Spec. 規格	A	B	C	D	E	F	G	I	Jaw Opening(Max.)				Weight Body
										J	J1	J2	J3	
BTCAS5200110	V-100V	101	380	440	85	48	80	125	16	135	200	240	330	26 KGS
BTCAS5200210	V-130V	131	445	505	95	55	85	150	18	190	250	300	390	39 KGS
BTCAS5200310	V-160V	161	535	595	105	58	100	165	18	250	330	370	480	59 KGS
BTCAS5200410	V-160VL	161	585	645	105	58	100	165	18	300	380	420	530	61 KGS
BTCAS5200510	V-200V	201	610	670	110	63	108	190	18	300	370	430	550	80 KGS

MC Mechanical Power Vise MODEL: MV

■ Feature / 特點

- One piece casting of vise bed and flexed jaw.
- Down thrust "Semis-sphere Segment" mechanism-eliminates jaw life and work tilt.
- Rigid material-vise body of ductile iron FCD60JIS (equal to GGG60) with 60 kgs/mm² or 80,000 psi tensile strength.
- Vise bed flame with harden treatment up to HRC 45° and up takes up wear and maintain for long.



Paralleling

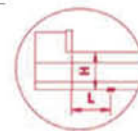

Angle Lock (prevent lifting)

Accuracy testing standard

NO	Item	JIS grade 1	Guaranteed	
1	Vise side-lock on bottom slide way square.	0.020 100mm	0.010 100mm	
2	Keyways on bottom of vise bed square to clamping surface of jaw plate.	0.020 100mm	0.015 100mm	
3	Both jaw plate parallel.	0.020 100mm	0.020 100mm	
4	Max opening test block parallel to bottom of vise body.	0.050 100mm	0.030 100mm	
5	Top of rectangular test block clamped tightly by jaw parallel to bottom of vise body.	0.030 100mm	0.020 100mm	
6	Surface of vise bed parallel to bottom of vise body.	0.020 100mm	0.015 100mm	

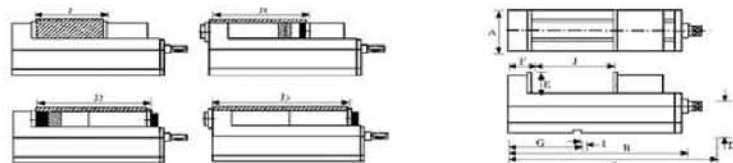

MC Mechanical Power Vise

Unit/mm

Code NO. 型號	Spec. 規格	A	B	C	D	E	F	G	I	Jaw Opening(Max.)				Clamping Force	Weight Body
										J	J1	J2	J3		
BTCAS5300110	MV-100V	101	400	490	85	48	80	125	16	155	200	240	330	3000 KGF	27 KGS
BTCAS5300210	MV-130V	131	445	555	95	55	85	150	18	230	250	300	390	3500 KGF	40 KGS
BTCAS5300310	MV-160V	161	555	645	105	58	100	165	18	300	330	370	480	4000 KGF	60 KGS
BTCAS5300410	MV-160VL	161	615	705	105	58	100	165	18	350	380	420	530	4000 KGF	62 KGS
BTCAS5300510	MV-200V	201	630	720	110	63	108	190	18	340	370	430	550	4500 KGF	81 KGS

Self Centring Vise 同動求心虎鉗: CV SERIES

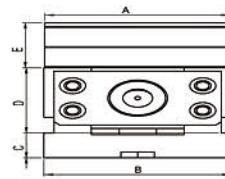
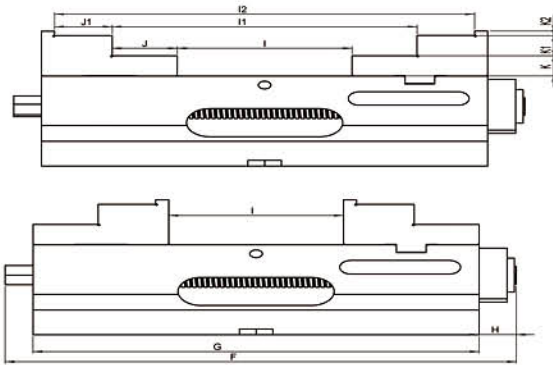
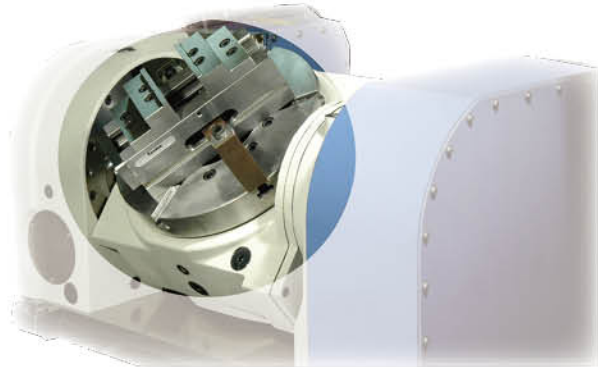

Code NO. 型號	Spec. 規格	A	B	C	D	E	F	G	H	I	I1	I2	J	J1	K	K1	K2
BTCAS5400110	CV-60	59	60	18	60	25	143	120	13	0-50	38-85	-	17.5	-	12.5	12.5	-
BTCAS5400210	CV-100	100	101	22	80	40	260	240	20	0-90	70-160	134-222	35	31	18	18	4
BTCAS5400310	CV-160	160	161		105	55	440	370	70	0-200	86-285	-	42.5	-	27.5	27.5	-

1. Self Centring Precision Vise is suitable for 4 and 5 Axis usage, either in horizontal or vertical machining.
2. Vise precision of its center repetition position is ± 0.01 mm.
3. Using high quality cast iron FCD 60 (GGG 60). Slideway has high frequency heat treatment at HRC 45° or more to keep the accuracy and its long use life.
4. Vise hard jaw material is full Steel and heat treatment at HRC 55° or more.
Thanks to its good design to use both sides of jaw since it is exchangeable.
5. Special design for the Self Centring Precision Vise to prevent work piece from bending during clamping and machining. Thus, it has the best solution in clamping the work piece.

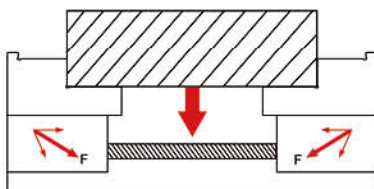

1. 同動式求心虎鉗適用四軸，五軸，立臥式 CNC 銑床之精密加工。
2. 虎鉗中心重複定位精度可保持 ± 0.01 mm。
3. 虎鉗本體材質使用球狀石墨鑄鐵 FCD60 (GGG60)，滑軌經高週波熱處理 HRC45° 以上，可保持高耐磨性。
4. 虎鉗鉗口採用全鋼材質，經熱處理硬度高達 HRC55° 以上，可拆換方向使用，變化性與互換性極佳。
5. 虎鉗特殊的結構設計，夾持工件時所產生的下壓力能有效防止工件上浮情形，鎖固力極佳。

夾持曲線圖
(CLAMPING CURVE)

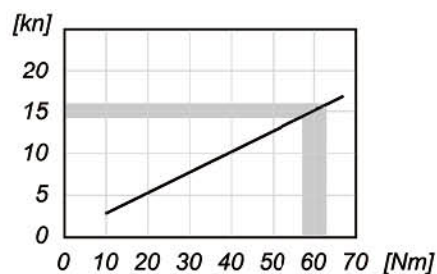

Self Centring Vise 同動求心虎鉗: CVR SERIES

Code NO. BTCAS5500110

Spec CVR-90

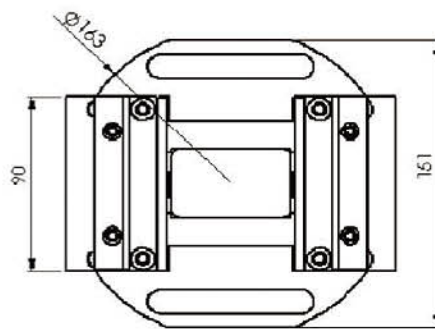

夾持曲線圖
(CLAMPING CURVE)

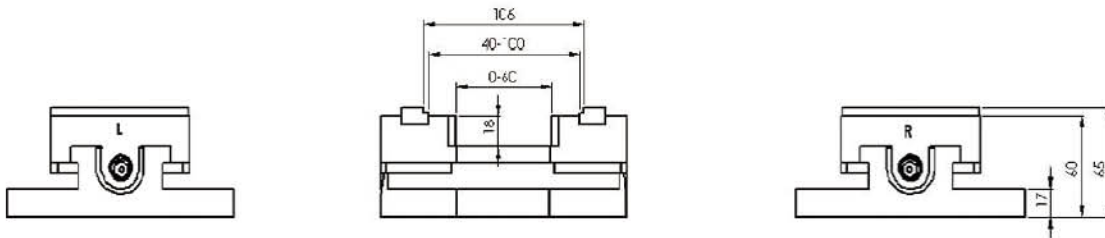
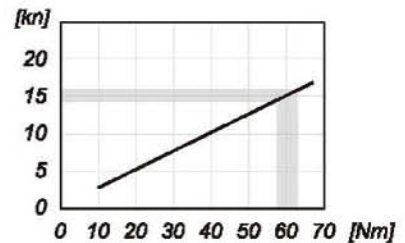

1. Self Centring Precision Vise is suitable for 4 and 5 Axis CNC Rotary Table usage, either in horizontal or vertical machining.
 2. Vise precision of its center repetition position is $\pm 0.01\text{mm}$.
 3. Using high quality alloy steel, slipway has high frequency heat treatment at HRC 45° or more to keep the accuracy and its long use life.
 4. Vise hard jaw material is full steel and heat treatment at HRC 55° or more, owing to its good design to use both sides of jaw since it is exchangeable.
 5. Special design for the Self Centering Precision Vise to prevent work piece from bending during clamping and machining. Thus, it has the best solution in clamping the work piece.
1. 同動式求心虎鉗適用四軸、五軸、CNC 分度盤、立臥式 CNC 銑床之精密加工。
 2. 虎鉗中心重複定位精度可保持 $\pm 0.01\text{mm}$ 。
 3. 虎鉗本體材質使用合金鋼，滑軌經高週波熱處理 HRC 45° 以上，可保持高耐磨性。
 4. 虎鉗鉗口採用全鋼材質，經熱處理硬度高達 HRC 55° 以上，可拆換方向使用，變化性與互換性極佳。
 5. 虎鉗特殊的結構設計，夾持工件時所產生的下壓力能有效防止工件上浮情形，鎖固力極佳。